



Prestige 51

Installation and User manual

959.146.00

WARNING

THIS MODEL OF PRESTIGE 51 (49158) IS **FOR USE WITH NATURAL GAS / GAS A ONLY**
NEVER CONVERT TO PROPANE GAS / GAS E

DANGER



**HOT GLASS WILL CAUSE BURNS.
DO NOT TOUCH GLASS
UNTIL COOLED.
NEVER ALLOW CHILDREN
TO TOUCH GLASS.**

A barrier designed to reduce the risk of burns from the hot viewing glass is provided with this appliance and must be installed for the protection of children and other at-risk individuals.

Installer: This manual should be kept with the appliance.
Consumer: Keep this manual for future reference.

Installation and service must be performed by a qualified gas installer, service agency or the gas fitter. Check local codes and read all instructions prior to installation.

Some materials used in the manufacturing process of this product can expose you to benzene which is known in the state of California to cause cancer and birth defects or other reproductive harm. For more information, go to www.P65warnings.ca.gov.

WARNING **FIRE OR EXPLOSION HAZARD**

Failure to follow safety warnings exactly could result in serious injury, death, or property damage.

Do NOT store or use gasoline or other flammable vapors and liquids in the vicinity of this or any other appliance.

WHAT TO DO IF YOU SMELL GAS

- **Do NOT** operate any appliance.
- **Do NOT** touch any electrical switch.
- **Do NOT** use any phone in your building.
- Immediately evacuate the area and contact the gas supplier. Follow the gas supplier's instructions.
- If you cannot reach the gas supplier, call the fire department.
- **Do NOT** turn on the gas supply until the gas leak(s) has (have) been repaired.

Installation and service must be performed by a qualified installer, service agency, or the gas supplier.

Canada

ENERGUIDE

**Look for the EnerGuide
Gas Fireplace Energy
Efficiency Rating in this brochure**

Based on CSA P.4.1-15



AMBIANCE[®]
FIREPLACES | BBQ | OUTDOORS | SPAS





i am
comfortable

The fire specialists since 1754

What could be cozier than a burning hearth fire? Whether you prefer a classic or a sleek design, at DRU you will find your ideal gas fire. Thanks to our knowledge and expertise - we can rely on 270 years' experience when it comes to providing comfortable, sustainable, safe heat and ambiance in your home - we will always offer the best solution for you. Our innovative craftsmanship is evident and can be found in each and every model in our series of modern gas fires, all of which satisfy extremely strict requirements in terms of sustainability, efficiency, emissions, safety and ease of use. After all, we keep improving, each and every year.

Installation Manual

1. Visual index	8
2. Introduction	10
3. Safety alert keys	10
3.1 Warnings	10
3.2 Measurements	10
3.3 Instruction key	11
4. General safety instructions	12
4.1 General safety warnings	12
4.2 Front clearance to combustible materials	14
5. Step-by-Step installation plan	15
6. Technical specifications	16
6.1 Rating plate sample	17
7. Unpacking and preparation	18
7.1 Unpacking	18
7.2 Checking the supplied parts	19
7.3 Preparing the appliance for installation	20
7.4 Pressure relief system check	22
7.4.1 Pressure relief hatches	22
8. Preparations at the installation location	24
8.1 Gas connection	24
8.1.1 Gas pressure	25
8.1.2 Gas shut-off valve	25
8.2 Electrical connection preparation	26
8.2.1 Grounding	26
8.2.2 Power supply	26
9. Installing and connecting the appliance	28
9.1 Installing the appliance	29
9.2 Connecting the gas supply and electricity	30
9.2.1 Check gas supply pressure	32
9.3 Remote control pairing	33
10. Venting	34
10.1 General venting requirements	34
10.2 Vent configurations	35
10.2.1 Definition of horizontal and vertical vent layout	35
10.2.2 Vent system with vertical termination cap (roof terminal)	36
10.2.3 Vent system with horizontal termination cap (wall terminal)	38
10.3 Clearances to the vent system	40
10.3.1 Clearances for installations with a horizontal termination cap	40
10.3.2 Clearances for installations with a vertical termination cap	42
10.4 Vent Installation	43

10.4.1 Permitted components	43
10.4.2 Firestop and wall thimble	43
10.4.3 Support and fastening	43
10.5 Chase construction	44
10.5.1 Zero-clearance shell	45
10.5.2 Framing and finishing requirements	45
10.5.3 Chase platform	45
10.5.4 Minimum framing dimensions	46
10.5.5 Heat release and air intake	47
10.5.6 TV recess	48
11. Adjusting and setting up the appliance	50
11.1 Micro Mesh Screen	50
11.1.1 Removing the Micro Mesh Screen	50
11.1.2 Replacing the Micro Mesh Screen	50
11.2 Appliance Control Cover	51
11.2.1 Removing the Appliance Control Cover	51
11.2.2 Installing the Appliance Control Cover	51
11.3 Door system	52
11.3.1 Opening and removing the door	52
11.3.2 Replacing the door	52
11.3.3 Replacing glass pane	52
11.4 Adjusting the appliance	54
11.4.1 Adjusting the restrictor slide	54
11.4.2 Removing the air inlet guides	56
11.5 Setting up the appliance	58
11.5.1 Positioning the log set's accessoires	60
11.5.2 Positioning the logs	62
12. Final check	66
12.1 Gas pressure/supply pressure	66
12.2 Ignition for the first time	67
12.3 Final check	67
12.4 First time using the appliance	67
13. Delivery	67
14. Maintenance	68
14.1 Maintenance guidelines	68
14.2 Components	68
15. Malfunctions	69

User manual	73
1. Safety	76
2. General safety instructions	78
2.1 Front clearance to combustible materials	78
2.2 Putting the appliance into operation	79
2.3 Heating for the first time	79
2.4 Discoloration of walls and ceilings	79
3. Operating the appliance	80
3.1 Drufire App	80
3.2 Home automation	80
3.3 Placing/replacing the batteries 	80
3.4 Remote control pairing	82
4. Remote control	83
4.1 Ignition  + 	83
4.2 Switching off the appliance 	83
4.3 Standby mode (Pilot flame)	84
4.4 Flame height adjustment	84
4.5 Designated low fire and high fire	84
4.6 Switching the second burner on/off	85
4.7 Thermostatic Mode 	85
4.8 Program Mode 	86
4.8.1 Activate/Deactivate Program Mode	86
4.8.2 Program Mode Setup	86
4.9 Eco Wave 	89
4.10 Eco Glow 	89
4.11 Temperature display in degrees Celsius or Fahrenheit	90
4.12 Setting the time	90
4.13 Countdown timer	91
4.14 Child lock	91
4.15 Software version	92
4.16 Remote Model Number	92
4.17 Remote control one button and two button ignition	92
5. Malfunction	93
5.1 Error code F	93
5.2 Resetting the remote control and appliance	94
6. Maintenance	95
6.1 Cleaning the glass pane(s)	95
6.1.1 Easy release door system	95
7. Environment	95
7.1 General	95
7.2 Appliance	95
8. Warranty	95

Appendix	97
A. Wifi-module and Drufire App	98
1. Drufire App	98
2. Installation of the Wifi-module	98
2.1 Wifi-module LED Status indicator	99
2.2 Resetting Wifi-module	100
B. Approved vent system terminations	101
C. Home automation	102
1. Modbus	102
1.1 Modbus 1 protocol	102
1.2 Modbus 2 protocol	102
D. Replacement parts	103
E. Diagram for connecting components	104
F. Warranty	106
1. Limited Lifetime Warranty	106
1.1 Conditions	106
1.2 Exclusions	107
2. Limitations of Liability	107
2.1 Warranty	107
2.2 How to Obtain Warranty Service	107

1. Visual index

In this visual index, all relevant components for installation and operation are shown. Each component name includes the corresponding chapter, with clickable links in the digital manual that jump to the relevant page when clicked.

💡 A digital version of this manual can be downloaded from www.druservice.us

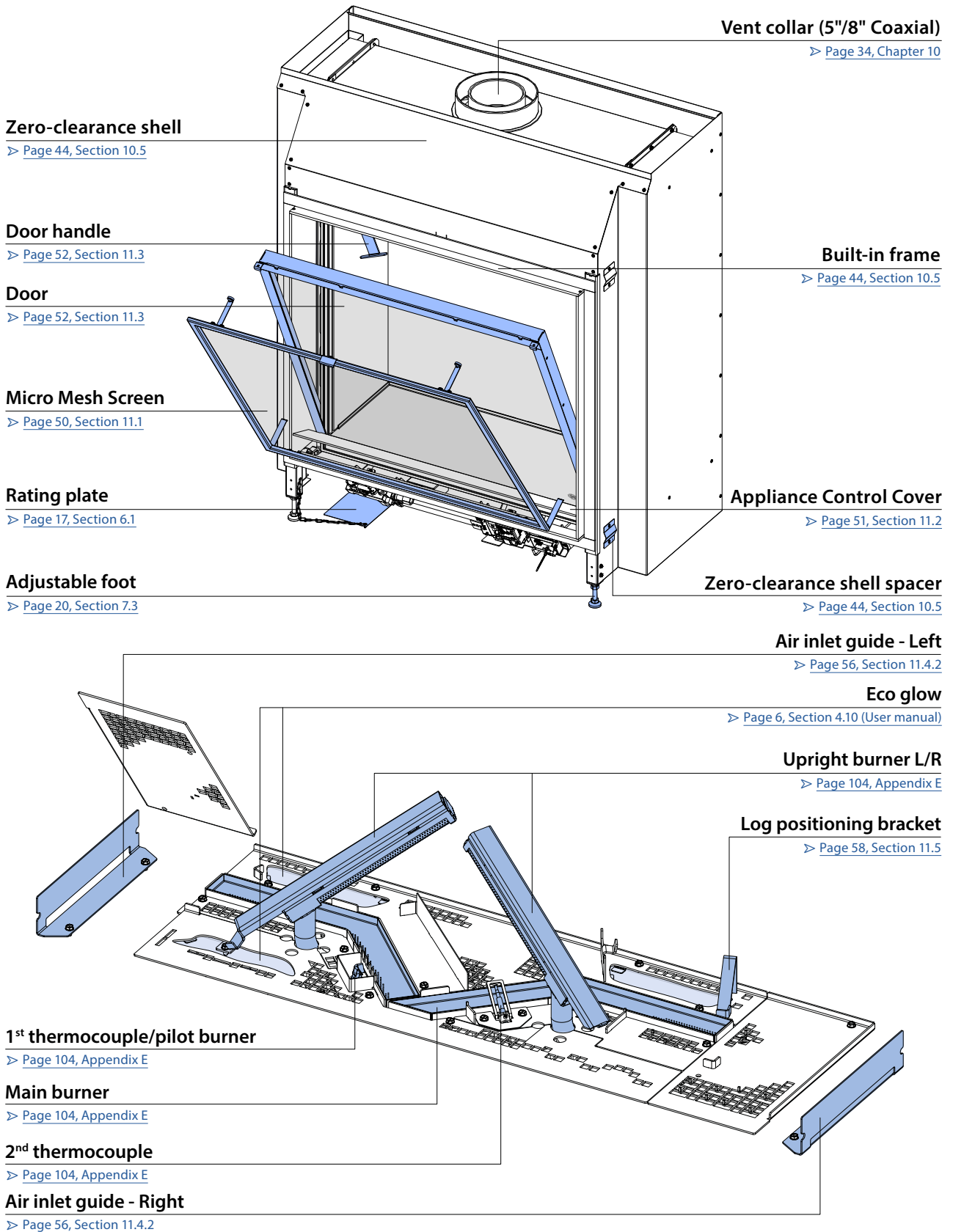

Main valve knob

Burner pressure adjustment

➤ [Page 67, Section 12.2](#)

Manual knob

Line pressuremeasuring nipple

➤ [Page 66, Section 12.1](#)

Burner pressure measuring nipple

➤ [Page 66, Section 12.1](#)

Gas out - Upright burners

➤ [Page 104, Appendix E](#)

Solenoid valve

➤ [Page 104, Appendix E](#)

Gas in

➤ [Page 104, Appendix E](#)

Gas out - main burner

➤ [Page 104, Appendix E](#)

Low setting adjustment

➤ [Page 67, Section 12.2](#)

Pilot line

➤ [Page 104, Appendix E](#)

Thermocouple interrupter

➤ [Page 104, Appendix E](#)

Gas out - Upright burners

➤ [Page 104, Appendix E](#)

Receiver

➤ [Page 104, Appendix E](#)

Wifi-module (optional)

➤ [Page 98, Appendix A](#)

2nd thermocouple

➤ [Page 104, Appendix E](#)

Control cable

➤ [Page 104, Appendix E](#)

Thermocouple interrupter

➤ [Page 104, Appendix E](#)

2nd gas valve

➤ [Page 104, Appendix E](#)

Ground

➤ [Page 26, Section 8.2.1](#)

Adapter for LED driver

➤ [Page 26, Section 8.2.2](#)

Strain relief

➤ [Page 26, Section 8.2.2](#)

Driver

➤ [Page 104, Appendix E](#)

2. Introduction

DRU, a manufacturer of gas-fired heating appliances, develops and produces products that comply with the highest possible quality, performance and safety requirements. This appliance has been tested and certified in accordance with CSA/ANSI Z21.88:2019 and CSA2.33:2019. The appliance is supplied with a combined installation and user manual. Installation and maintenance of the appliance should be performed by a professional certified expert with proved knowledge and demonstrable competence in this field.

A professional expert takes all technical aspects such as heat output, gas connection and electricity into account, as well as the combustion gas discharge requirements. The information in this installation manual will guarantee that the appliance is installed in such a way that it will function properly and safely. If the installation instruction is not clear, national/local regulations must be observed.

This manual discusses the installation of the appliance and the regulations that apply to the installation. In addition, the appliance's technical data is shown and information is provided about maintenance, possible malfunctions that might occur and their possible causes.

Before starting with the installation, always check whether there is a new update of this document available on www.druservice.us and www.druservice.ca. The digital PDF version features an interactive index, visual index and step-by-step checklist. If you click the links in the PDF, the document will automatically jump to the relevant page.

Make sure to carefully read and understand the contents of this installation manual before installing the appliance. After final delivery, the manual must be handed over to the user.

3. Safety alert keys

3.1 Warnings

The following symbols and statements are used throughout this manual to indicate important information:



ACTION

Written step-by-step instructions to be followed as described.



DANGER

Indicates a hazardous situation that, if not avoided, **WILL** result in death, serious injury, or property damage.



WARNING

Indicates a hazardous situation that, if not avoided, **COULD** result in death, serious injury, or property damage.



CAUTION

Indicates a hazardous situation that, if not avoided, **WILL** result in a minor or moderate injury.



NOTICE

Indicates practices that are important, but not related to personal injury.

3.2 Measurements

Throughout this manual, dimensions will appear as (see Fig 3-1):

Imperial measurement X [Metric measurement X]



NOTICE

All measurements in this manual have been converted from metric to imperial and are rounded to the nearest 1/16".

- Refer to the specified metric dimensions when a high level of accuracy is required.
- Refer to the specified metric values when a high level of accuracy is required.

3.3 Instruction key

The following symbols are used in the manual to indicate important information:

Throughout this manual, symbols and indicators are used in the illustrations (see Fig. 3-1):

- Dark gray highlighted components indicate the tools that need to be used for this action.
- A blue highlighted component/area is the focal point of this step.
- A white arrow shows the necessary movement.
- A gray arrow shows the needed point of view.

Assembly







Loosen, adjust and retighten



Tighten completely





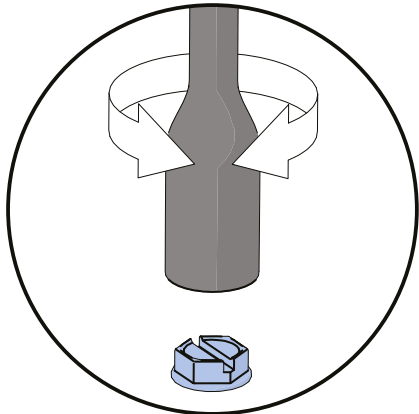

Unscrew

Tighten halfway



Loosen halfway

-  Socket head screwdriver
-  Phillips head screwdriver
-  Flathead screwdriver
-  Allen key
-  Socket wrench





- Sheet metal screw 
- Phillips head screw 
- Flat head screw 
- Socket head cap screw 
- Hex nut 

Symbols / Tooltips

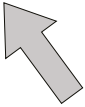

Highlighted components

Movement direction

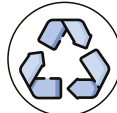

View direction

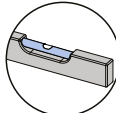
Not allowed

Recycle items

Level

Measurements



Imperial measurement X [Metric measurement Y]

< Smaller than

> Greater than

≥ Equal or greater than

≤ Equal or smaller than

3 - 1

38C-2893

4. General safety instructions

4.1 General safety warnings

A DRU appliance must be installed in accordance with the instructions shown in this document. Carefully read all the instructions and warnings before starting with the installation process. It is the sole responsibility of the installer to make sure this appliance is installed in compliance with the instructions and all applicable codes. Consult your local inspector to determine the need for a permit or license prior to starting the installation.

For the installation process it is imperative to wear the appropriate safety gear to guarantee personal protection and adherence to safety standards. This includes but is not limited to:

- **Protective gloves** to shield hands from sharp edges, hot surfaces, and potential chemical exposure.
- **Safety goggles** or a face shield to safeguard eyes from debris, sparks, and chemicals.
- **Respiratory protection** such as a respirator or mask equipped with appropriate filters to prevent inhalation of harmful gases, fumes, or particulates.
- **Flame-resistant clothing** to minimize the risk of burns from accidental contact with hot surfaces or flames during soldering, brazing, or testing of gas lines.
- **Safety boots** with slipresistant soles to provide stability and protection against punctures or crushing injuries.
- **Hearing protection** such as earplugs or earmuffs to reduce the risk of hearing damage.

Additionally, make sure there is adequate ventilation in the workspace to prevent the accumulation of combustible gases and maintain a safe working environment.



DANGER

- Do not make **ANY** changes or modifications to the appliance.
- Installation is **NOT ALLOWED** in a manufactured home (USA only), mobile home or recreational vehicle.



WARNING

- Be sure to review all safety warnings and installation guidelines contained in this manual. Consider the installation location, vent configuration, clearances, structural requirements, framing, finishing materials and local codes.
- Improper installation, adjustment, alteration, service, or maintenance can cause injury or property damage. Refer to the owner's information manual provided with this appliance. For assistance or additional information, consult a qualified installer, service agency or the gas supplier.
- **ALL** warnings and instructions apply to all products manufactured and distributed by DRU.
- The Micro Mesh Screen designed to reduce the risk of burns from the hot viewing glass is provided with this appliance and must be installed. The appliance **MUST** not be used without the Micro Mesh Screen in place. If the barrier becomes damaged, the barrier must be replaced with the manufacturer's barrier for this appliance.
- Installation and service on the appliance and vent system must be done by an authorized DRU qualified installer, service agency, or gas supplier. If these components are not installed by an authorized DRU dealer/installer, the warranty of all components will be void. DRU cannot be held responsible for any damage caused by improper installation.
- The appliance should be inspected before use and at least annually by a professional service person. More frequent cleaning may be required. Control compartments, burners, and circulating air passageways of the appliance must be kept clean. Any alteration to the product can cause soot or carbon to form and may result in damage. DRU cannot be held responsible for any damage that results from not following the instructions outlined in this manual.
- All materials and objects used to carry out the installation are prescribed by DRU. Do **NOT** install the system using different materials or objects than those approved for installation by DRU.
- Do not cover the appliance and/or do not wrap it in an insulation blanket or any other material.
- If the glass is **NOT** properly secured in place, the glass is cracked, you smell gas or you have doubts about the safe operation of the fireplace, immediately shut off the main gas supply, leave the building and call a qualified, professional engineer to inspect the installation. Any parts that are damaged or have been under water must be replaced.
- All electrical connections must be properly installed, insulated, and secured to avoid potential **ELECTRICAL SHOCK**, a **FIRE HAZARD**, or a malfunction of the system. Consult local building code requirements. In the absence of local codes, refer to the National Electric Code, ANSI/NFPA 70, or the Canadian Electric Code (CSA C22.1).



NOTICE

- All pictures/diagrams shown in this manual are for illustration purposes only. The actual product may vary due to product enhancements.
- Local codes and regulations that are more stringent than the requirements in this manual take precedence over DRU requirements.

⚠ WARNING CARBON MONOXIDE POISONING HAZARD

Failure to follow the steps outlined below for each appliance connected to the venting system being placed into operation could result in carbon monoxide poisoning or death. The following steps shall be followed for each appliance connected to the venting system being placed into operation, while all other appliances connected to the venting system are not in operation:

- 1) Seal any unused openings in the venting system.
- 2) Inspect the venting system for proper size and horizontal pitch, as required in the National Fuel Gas Code, ANSI Z223.1/NFPA 54 or the Natural Gas and Propane Installation Code, CSA B149.1 and these instructions. Determine that there is no blockage or restriction, leakage, corrosion and other deficiencies which could cause an unsafe condition.
- 3) As far as practical, close all building doors and windows and all doors between the space in which the appliance(s) connected to the venting system are located and other spaces of the building.
- 4) Close fireplace dampers.
- 5) Turn on clothes dryers and any appliance not connected to the venting system. Turn on any exhaust fans, such as range hoods and bathroom exhausts, so they are operating at maximum speed. Do not operate a summer exhaust fan.
- 6) Follow the lighting instructions. Place the appliance being inspected into operation. Adjust the thermostat so appliance is operating continuously.
- 7) Test for spillage from draft hood equipped appliances at the draft hood relief opening after 5 minutes of main burner operation. Use the flame of a match or candle.
- 8) If improper venting is observed during any of the above tests, the venting system must be corrected in accordance with National Fuel Gas Code, ANSI Z223.1/NFPA and/or Natural Gas and Propane Installation Code, CSA B149.1.
- 9) After it has been determined that each appliance connected to the venting system properly vents when tested as outlined above, return doors, windows, exhaust fans, fireplace dampers and any other gas-fired burning appliance to their previous conditions of use.

The installation must comply with local codes or, in the absence of local codes, the National Fuel Gas Code, ANSI Z223.1/NFPA 54, or the Natural Gas and Propane Installation Code (CSA B149.1).

The appliance, when installed, must be electrically grounded in accordance with local codes or, in the absence of local codes, with the National Electrical Code, ANSI/NFPA 70, or the Canadian Electrical Code, CSA C22.1.

If you do not follow these instructions exactly, a fire or explosion may result causing property damage, personal injury, or loss of life.

Always keep the area on and near the appliance free from combustible materials, gasoline and other flammable vapors and liquids.

Do not operate the appliance with the glass front removed, cracked, or broken. Replacement of the glass must be done by a licensed or qualified service person.

Do not use this appliance if any part has been under water. Immediately call a qualified service technician to inspect the appliance and to replace any part of the control system and any gas control that has been under water.

Any safety screen, guard, or barrier removed for servicing an appliance, must be replaced prior to operating the appliance

Young children should be carefully supervised when they are in the same room as the appliance. Toddlers, young children, and others may be susceptible to accidental contact burns. A physical barrier is recommended if there are at-risk individuals in the house. To restrict access to an appliance or stove, install an adjustable safety gate to keep toddlers, young children, and other at-risk individuals out of the room and away from hot surfaces.

Installation and repair should be done by a qualified service person. The appliance should be inspected before use and at least annually by a professional service person. More frequent cleaning might be required due to excessive lint from carpeting, bedding material, etc. It is imperative that control compartments, burners, and circulating air passageways of the appliance be kept clean.

Due to high temperatures, the appliance should be located out of traffic and away from furniture and draperies.

Only doors certified with the appliance shall be used.

Children and adults must be alerted to the hazards of high surface temperature and should stay away to prevent burns or clothing ignition.

4.2 Front clearance to combustible materials

The zone in front of the appliance has a minimum clearance distance to combustible materials (see Fig. 4-1). The area is measured starting from the face of the Micro Mesh Screen to the space in front of the appliance.



WARNING

- No materials and objects of any kind are allowed inside the red zone (see Fig. 4-1).
- Non-combustible materials may be placed inside the blue zone (see Fig. 4-1).

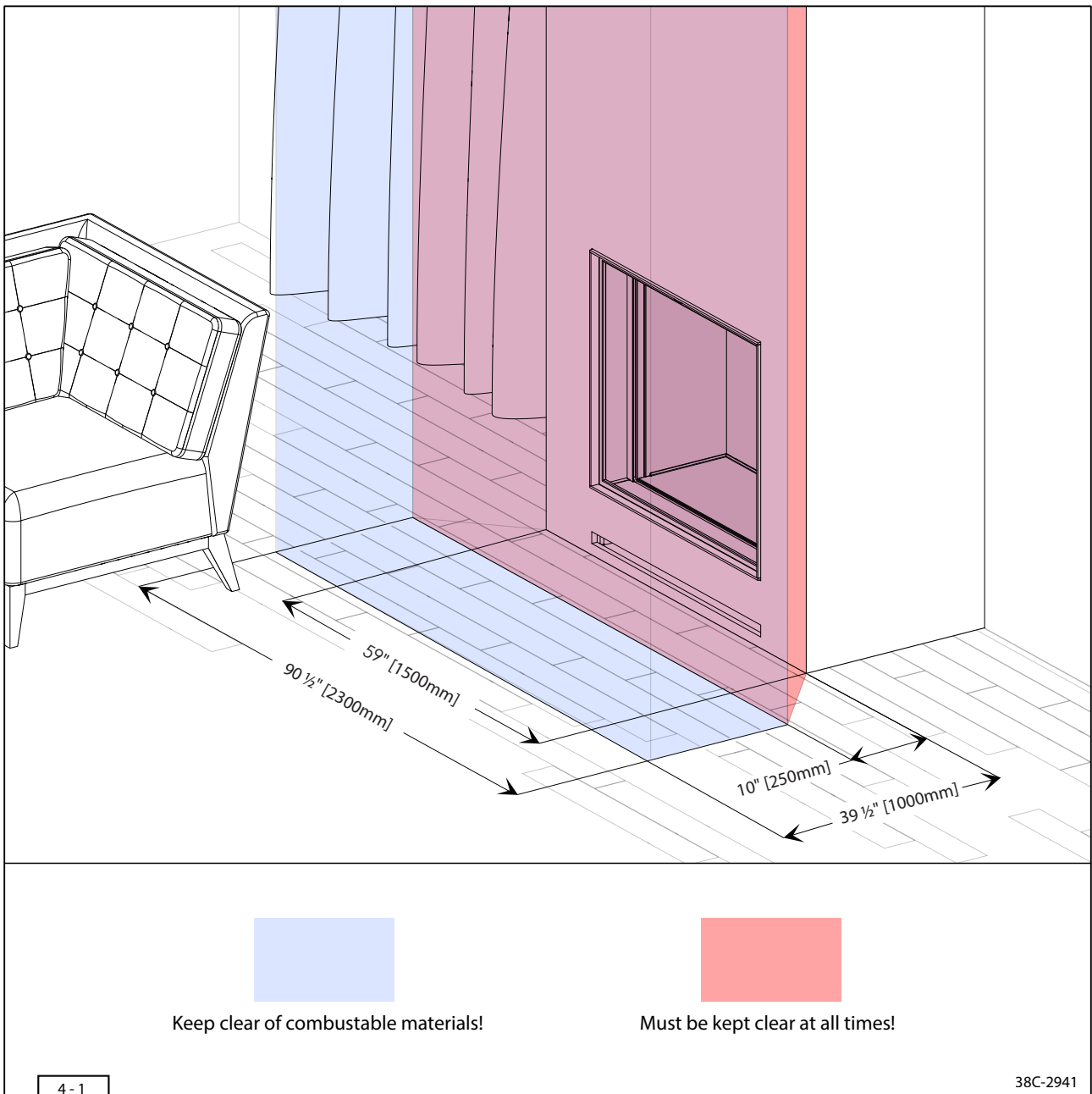

5. Step-by-Step installation plan

The major points of attention to install the appliance are listed below. After finishing and ticking off each step, the appliance will be ready for use. **ONLY** use this list as a guide after a thorough readthrough of the manual.

PREPARATION

- Unpack the appliance ([Chapter 7.1, Page 18](#))
- Check if the correct appliance was delivered, including all components ([Section 7.2, Page 19](#))
- Inspect the appliance and its components for any signs of damage or irregularities ([Section 7.2, Page 19](#))
- Install and adjust the adjustable feet, ensuring stability and alignment ([Section 7.3, Page 20](#))
- Make sure the explosion relief system functions as required ([Section 7.4, Page 22](#))
- Check if the correct gas type and gas pressure is available at the installation location ([Chapter 8, Page 24](#))
- Ensure gas line sizing and pressure meet the requirements ([Section 8.1, Page 24](#))
- The service shut-off valve meets local requirements and is accessible after installation ([Section 8.1, Page 24](#))
- Install a permanent outlet and grounding connection with proper wire and connector ([Section 8.2, Page 26](#))

APPLIANCE INSTALLATION

- Transfer the appliance from the pallet to its designated installation spot and level ([Chapter 9, Page 28](#))
- Connect the gas pipe to the appliance, ensuring a secure connection ([Section 9.2, Page 30](#))
- Conduct a thorough leak check after opening the gas valve [9.2](#)
- Bleed the gas line ([Section 9.2, Page 30](#))
- Ground the appliance by connecting it to the location's grounding circuit ([Section 9.2, Page 30](#))
- Connect the appliance to a 120V power supply using the provided adapter ([Section 9.2, Page 30](#))
- Pair the wireless remote control with the appliance ([Section 9.3, Page 33](#))

VENT INSTALLATION

- The correct type and size of vent system is used, following manufacturer specifications ([Chapter 10, Page 34](#))
- Calculate the flue length, offsets and angles accurately ([Section 10.2.1, Page 35](#))
- Use provided graphs and tables to determine if the chosen flue setup is allowed (Roof: [10.2.2](#) / Wall: [10.2.3](#))
- Adjust the appliance according to the selected configuration (Roof: [10.2.2](#) / Wall: [10.2.3](#))
- Ensure compliance with regard to clearances ([Section 10.3, Page 40](#))
- Install vent run according to specified requirements ([Chapter 8, Page 24](#))

CHASE CONSTRUCTION

- The construction of the chase meets the specified guidelines and building codes ([Section 10.5, Page 44](#))
- The chase construction conforms with the specified requirements ([Section 10.5, Page 44](#))
- Ensure a recess is constructed if a tv set when installed above the appliance ([Section 10.5.6, Page 48](#))

APPLIANCE SET-UP AND OPERATION

- Carefully unpack the log set contents, ensuring all components are present ([Section 11.5, Page 58](#))
- Position the contents of the log set according to the provided instructions (Section 11.5.1 / 11.5.2)
- Review warning guidelines before ignition, adhering to safety protocols ([Chapter 12, Page 66](#))
- Open gas supply, check pressure on gas control, and compare with specified values ([Section 12.1, Page 66](#))
- Verify correct operation from cold condition ([Section 12.2, Page 67](#))
- During delivery, provide user instructions on appliance operation and safety ([Chapter 13, Page 67](#))

6. Technical specifications

Table 6-1: Technical data

Model name	DRU Prestige 51
Tested and certified with	CSA/ANSI Z21.88:2019, CSA2.33:2019
Appliance class	C290104, C290184
Altitude range	US: 4% input reduction for each 1000ft above sea level CA: 0 - 4500 ft. [0 - 1370m]
Combustion type	Closed combustion
Pressure equalisation	Explosion hatches
Flame protection	Seperated thermocouples
Ignition system	Electric ignition with pilot flame
Vent system	
Vent system	Direct-vent 5"x8" (Concentric)
Concentric appliance connection	Duravent
Applicable venting systems	Duravent DirectVent Pro (58DVA series) Selkirk Direct-Temp System (5DT series) BDM Pro Form Direct vent system (DVR8 series)
Chase ventilation	Minimal net air-in: ≥58 sq." [375cm ²] Minimal net air-out: ≥200 sq." [1400cm ²]
Heat	
Min. dist. to combustibles - Front	39.5" [1000mm]
Min. dist. to combustibles - Sides and Rear	20" [500mm]
Gas settings (Natural gas)	
Nominal inlet pressure	7.0 W.C." [1,74 kPa]
Minimum inlet pressure	4.1 W.C." [1,04 kPa]
Maximum inlet pressure	10.5 W.C." [2,61 kPa]
Manifold pressure	3.6 W.C." [0,89 kPa]
Low setting pressure	3.5 W.C." [0,87 kPa]
High setting pressure	3.7 W.C." [0,93 kPa]
Maximum input	50,5 kBtu/hr
Minimum input	21,3 kBtu/hr
Pilot injector	BL22N
Main burner injector	Left: 1,45mm Right: 1,45mm
Upright burner injectors	Left: 1,85mm Right: 1,90mm
Electric	
Adapter input	100–240V~ 0.5A 50/60Hz
Adapter output	24VDC 0,5A
Max. power consumption	3,6W
Remote control	
Tansmitting frequency	918mHz
Batteries	2x AAA (Alkaline)

6.1 Rating plate sample



Below the rating label is shown that is fixed to the appliance. The label is glued to a metal plate connected to the front left leg using a chain. The rating label must remain accessible below the Appliance Control Cover after the appliance has been installed.

Because of constant updates to our products, it is possible to find differences between the label shown below and the one attached to the appliance. The label on the appliance is always the correct one.



NOTICE

The rating plate must remain attached to the appliance by means of the chain at all times.

DO NOT REMOVE THIS LABEL / NE PAS ENVELER CETTE ÉTIQUETTE					
 DRU Verwarming B.V. Ratio 8, 6921 RW Duiven The Netherlands Tel: +31 (0)26 319 5 319		 000000			
49158 PRESTIGE 51 RCS GLSDCR LED					
Serial number / Numéro de série		000000			
Certified according to / Certifié selon		CSA/ANSI Z21.88.2019 CSA 2,33-2019			
Altitude rating / Estimation d'altitude		CAN : 0 - 4500 Ft. / 0 - 1370 m. US : 4% input reduction for each 1000FT above sea level			
Electrical rating/Estimation électrique		120V / 60Hz less than / moins de 0,5A			
VENTED GAS FIREPLACE HEATER - NOT FOR USE WITH SOLID FUEL. FOYER AU GAZ À EVACUATION - NE PAS UTILISER AVEC DU COMBUSTIBLE SOLIDE.					
THIS VENTED GAS FIREPLACE HEATER IS NOT FOR USE WITH AIR FILTERS. NE PAS UTILISER DE FILTRE À AIR AVEC CE FOYER AU GAZ À EVACUATION.					
FOR USE WITH GLASS DOORS CERTIFIED WITH THE APPLIANCE ONLY. POUR UNE UTILISATION AVEC DES PORTES EN VERRE CERTIFIÉES AVEC L'APPAREIL UNIQUEMENT.					
VENTED GAS FIREPLACE HEATER FOYER AU GAZ À EVACUATION		Natural gas / Gaz Naturel			
Max. input / Débit max.		50.5 kBtu/hr			
Min. input / Débit min.		21.3 kBtu/hr			
Main burner injector (L/R) Injecteur de brûleur principal (G/D)		1,45 / 1,45			
Upright burner injectors (L/R) Injecteurs de brûleur vertical (G/D)		1,85 / 1,90			
Gas inlet pressure Pression d'entrée de gaz		7.0 (W.C.) / 1,74 kPa			
Gas manifold pressure Pression d'alimentation		3.6 (W.C.) / 0,89 kPa			
Clearances to Combustibles (with included standoffs) Espace par rapport aux matériaux inflammables (avec entreloises)					
Sides Cotes	0" / 0 mm	Back Arrière	0" / 0 mm	Front Devant	39.5" / 1000 mm

38C-2935

7. Unpacking and preparation

Before installing the appliance, it's essential to unpack and prepare it properly. This ensures safety and smooth installation, while also guaranteeing that all components are in optimal condition.



WARNING

- If there is damage, contact the supplier before installing the appliance.
- **NEVER** install an appliance that is damaged and/or faulty!
- Keep plastic bags and other packaging materials away from children.



NOTICE

- Make sure you do not damage the appliance and supplied parts when unpacking and disassembling.
- Dispose of the packaging material in accordance with local legislation and related waste/recycling resources.
- The glass pane of the appliance is made of a ceramic material. Very small irregularities in the glass panes cannot be avoided and therefore fall within the quality standards set by DRU.

7.1 Unpacking

When unpacking the appliance, proceed as follows (see Fig. 7-1):

- Remove the two panels of the large side on the crate by unscrewing them (Step 1).
- Remove the top side of the crate by unscrewing it (Step 2).
- Remove the protection from the 5"/8" coaxial vent collar of the appliance (Step 3).
- Remove the remaining side panels of the crate by unscrewing them from the pallet (Step 4).
- Remove all items and materials from the pallet except the appliance itself (see Fig. 7-1, Step 5).
- Remove the piece of protective foam from the Micro Mesh Screen (See chapter 11.1).
- Remove the protective film from the Appliance Control Cover (See chapter 11.2).
- Make sure to thoroughly read the label on the glass pane, comply with its instructions and remove.

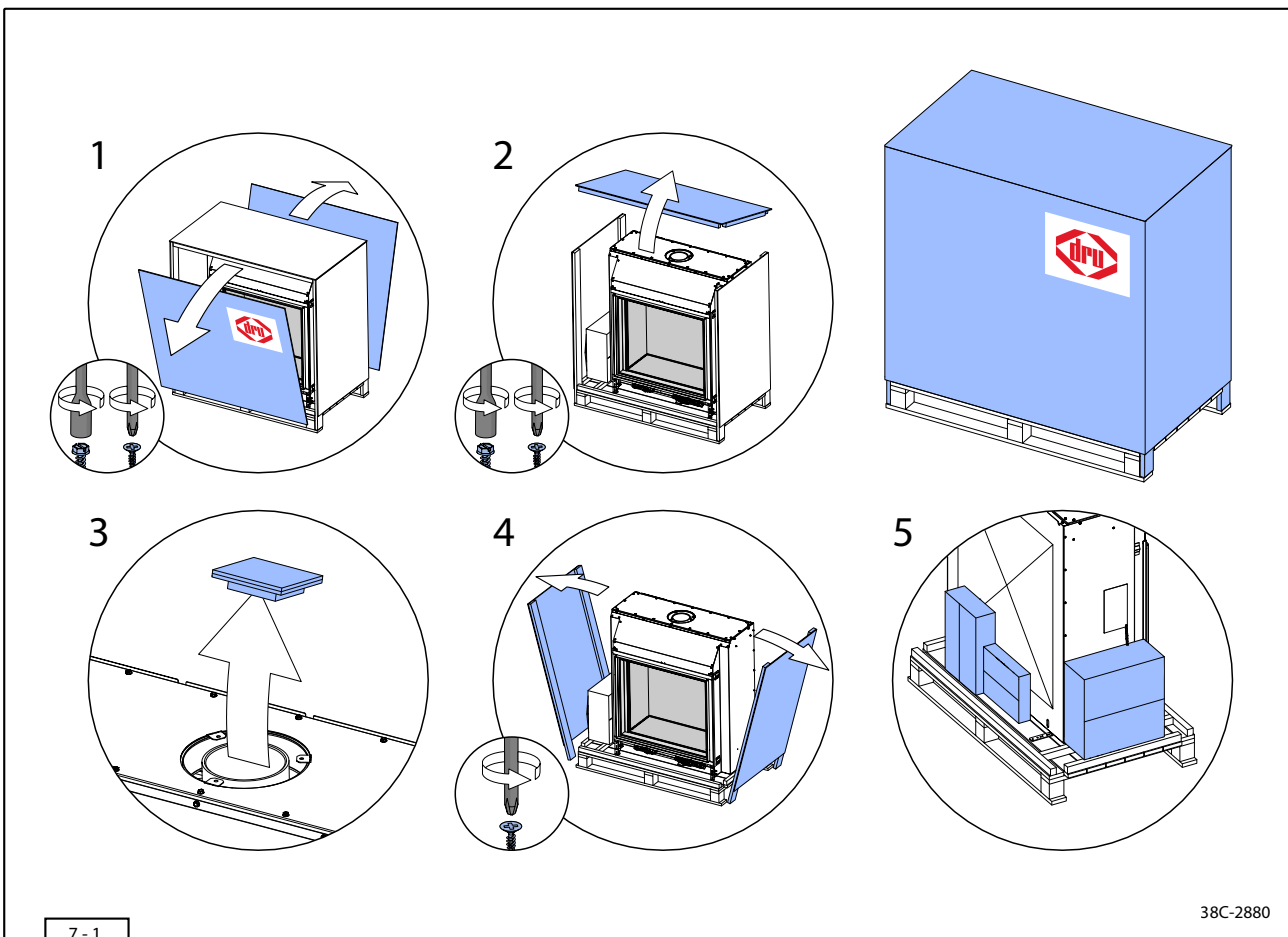

7.2 Checking the supplied parts

When unpacking the appliance, proceed as follows:

- Remove the boxes and individual parts from the pallet (see Fig. 7-1, Step 5)
- Check the appliance for (transportation) damage.
- Open the boxes and check the contents for completeness and possible damage using Table 7-1.



NOTICE

The glass pane is made of a ceramic material. Very small irregularities in the glass panes cannot be avoided and are therefore within the required quality standards set by DRU.

Table 7-1: Parts included with the delivery

Description	Contents	Amount
Documents	Installation and User manual	1
Log set	Logs	11
	Vermiculite	1
	Ceramic flakes, black	1
	Ceramic flakes, gray	1
	Ash	1
Glowing ember set	Forge embers, black	1
	Forge embers, gray	1
	Glowing embers, orange	2
Accessories	Restrictor slide	1
	Power supply (24 V adapter)	1
	Remote control	1
	Battery (AAA)	2
	Self-tapping screws	Nx
	8mm socket screwdriver	1
	Adjustable foot	1
	Cable tie (Heat resistance: 300°F [150°C])	2
	Air inlet guides - High (¾" [20mm])	2
Individual components	Micro Mesh Screen	1
	Appliance Control Cover	1

7.3 Preparing the appliance for installation

The adjustable feet of the appliance are used to make sure that it is level at the installation location. Upon delivery, there is no adjustable foot installed on the front right corner of the appliance. The individually delivered adjustable foot is **NOT** optional and must be installed before the appliance is installed. The steps below describe how the adjustable feet must be installed and adjusted.



CAUTION

- The front-right adjustable foot has a fixed stop that guarantees the minimum appliance installation height of $7\frac{7}{8}$ " [200mm] (measured from the built-in frame on the bottom side up to the floor area). The other leveling feet must be adjusted at the same distance before installation. Adjusting at a lower position than the stop allows is not permitted.
- Always perform the steps below with two persons. Always have the appliance be supported by the second person when removing the transportation brackets and installing/adjusting the adjustable feet so that the appliance cannot fall over.



NOTICE

- Take measures to prevent damage to the Micro Mesh Screen during the steps below.
- The rating plate must be accessible and remain attached to the appliance by means of the chain at all times.

Proceed as follows for installing and adjusting the adjustable feet (see Fig. 7-2):

- Take the individual adjustable foot from the box with accessories and keep it within hand's reach.
- Unscrew the four transportation brackets from the pallet (Step 1).
- Unscrew the brackets from the appliance and remove them with the exception of the transportation bracket on the front right (Step 2).
- Carefully tilt the appliance towards the rear so that the two adjustable feet at the front can be adjusted. Have a second person support the appliance during the following steps so that a safe workplace is guaranteed and the appliance is prevented from tipping over (Step 3).
- Remove the transportation bracket on the front right side of the appliance by unscrewing the two self-tapping screws (Step 4).
- Screw the supplied adjustable foot on the front right into the appliance up to the stop. Use two wrenches to fasten it (Step 5).
- Unscrew the adjustable foot on the front left from the appliance and adjust it to $2\frac{9}{16}$ " [65mm]. The two front adjustable feet are now aligned with each other. Fasten by using two wrenches (Step 6).
- Carefully allow the appliance to be supported by the adjustable feet again.
- Carefully tilt the appliance towards the front so that the two adjustable feet at the rear can be adjusted. Have a second person support the appliance during the following steps so that a safe workplace is guaranteed and the appliance is prevented from tipping over (Step 7).
- Adjust the two adjustable feet on the rear side of the appliance to $2\frac{9}{16}$ " [65mm] so that they are at the same height when compared to the two front adjustable feet. Fasten both by using two wrenches (Step 8).
- Carefully allow the appliance to be supported by the four adjustable feet (Step 9).

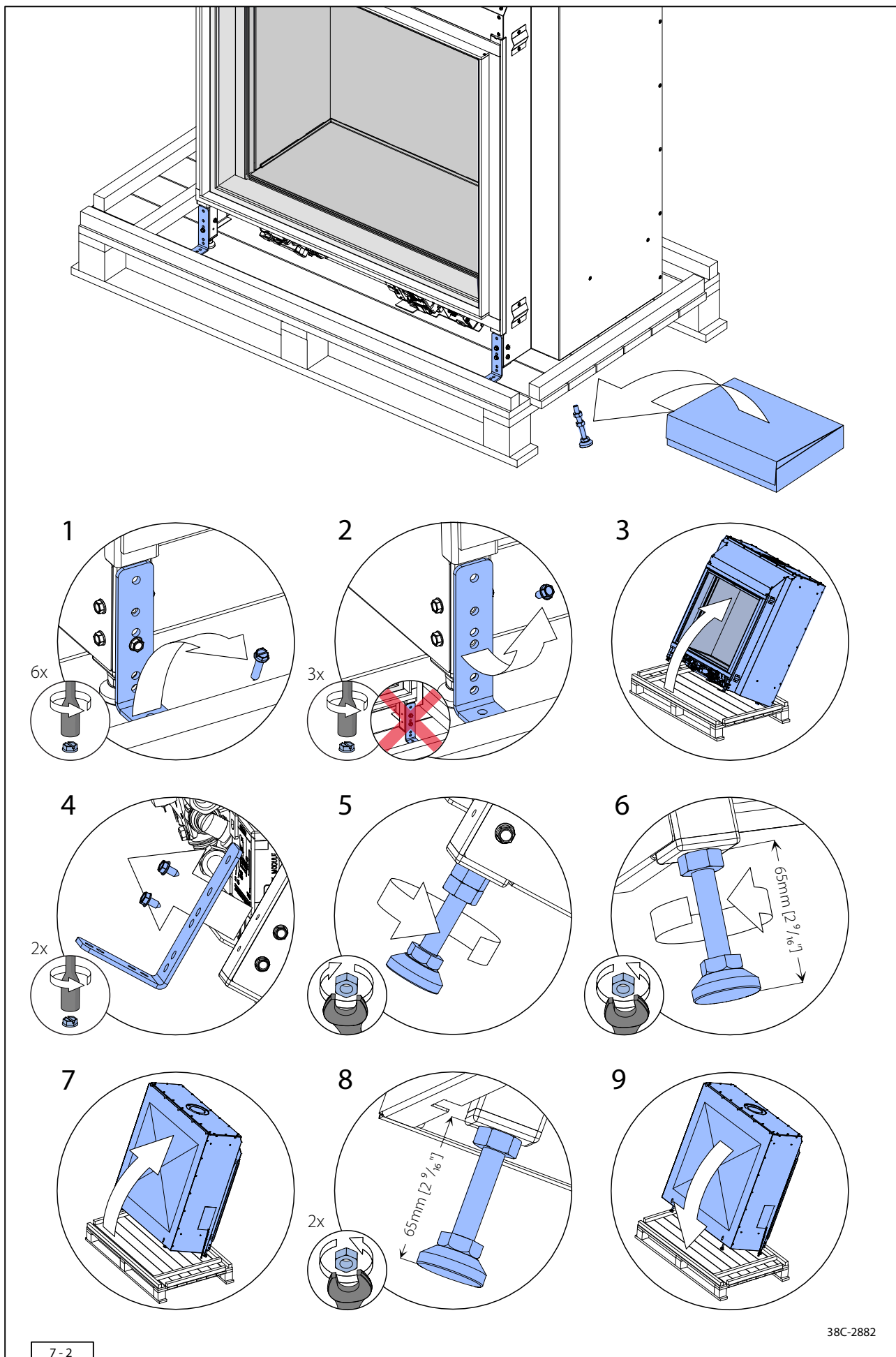

7.4 Pressure relief system check

The appliance features an pressure relief system that consists of two pressure relief hatches. It is essential that these function propely in case of an explosion. The movement and sealing capability of the pressure relief system always needs to be checked before installing and after service/maintenance work.



DANGER

- A thorough inspection of the pressure relief system **MUST** be carried out as descibed below before starting with installation process.
- Stop immediately and contact the distrubutor when improper functioning of **ANY** pressure relief component is found:
 - A faulty seal on the gasket of the pressure relief hatches will result in exhaust particles leaking into the living space resulting in possible carbon monoxide poisoning.
 - A seized/obstructed pressure relief system prevents the escape of the expanding gasses during an explosion resulting in very dangerous situations.

7.4.1 Pressure relief hatches

Carefully follow the steps and checks below (see Fig. 7-3):

- Remove the door, Appliance Control Cover and Micro Mesh Safety screen as described in chapter 11.
- Remove the flue gas distribution plate as described in the 2nd and 3rd step of section 11.4.
- From the inside of the appliance push up on the left pressure hatch several times while cycling trough the full range of motion (Range: ~1 3/4" [45mm]). Check and verify free and unobstructed movement across the full range (Step 1^a and 1^b, Left hatch pictured).
- Check the seal of the left hatch to the appliance in neutral position. The gasket must seal off the appliance across the complete circumference (Step 2, top left pictured).
- Repeat the check on the right pressure relief hatch (Step 1^a, 1^b and 2).

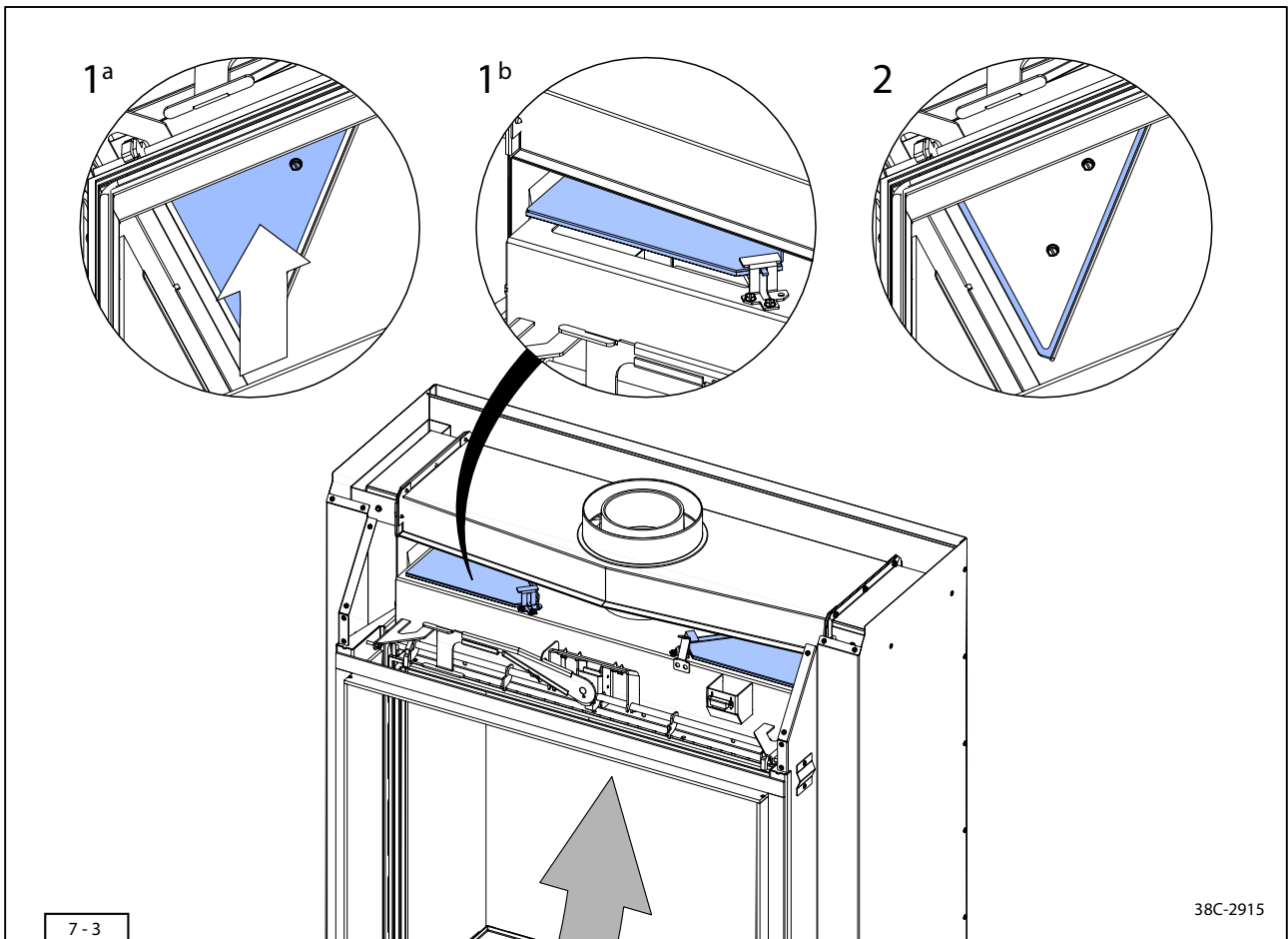

8. Preparations at the installation location

Carefully read and follow the guidelines below before proceeding with the installation:



DANGER

After the gas line is connected, each appliance connection, valve, and valve train **MUST** be checked while under normal operating pressure with either a liquid solution or leak detection device to locate any sources of leaks. Tighten any areas where bubbling appears or a leak is detected until the bubbling stops completely or the leak is no longer detected. **DO NOT** use a flame of any kind to test for leaks. A fire or explosion will occur, causing serious injury, property damage or death.



WARNING

- Make sure there is no dirt in the gas pipes and connections.
 - Use a gas pipe with the correct dimensions so that no pressure loss can occur.
 - No soldering may take place at the flexible gas hose(s) as this could cause leaks.
 - Install a gas valve in accordance with the applicable regulations.
 - Before putting the fire into operation, check the complete installation for gas tightness.
 - Do not ignite the appliance before it has been fully installed.
- These products and the fuels used to operate them (natural gas) and combustible products of such fuels can expose you to chemicals including benzene, carbon monoxide, and ceramic fibers, which are known to the state of California to cause cancer and/or reproductive harm. For more information, visit: www.p65warnings.ca.gov.
 - Use new, properly reamed pipes free from debris. When tubing is used, assure that ends are straight, deburred and clean. All tubing bends must be smooth and free of distortion.
 - Check whether the appliance is suitable for the type of gas and the gas pressure used at the location.
 - Read these instructions carefully. Failure to follow them could result in a fire or explosion causing property damage, personal injury, or loss of life. The product must be installed and operated in accordance with all codes and local regulations.
 - Do **NOT** bend tubing at gas valve connection points after the compression fitting has been tightened. This can result in a gas leak at the connection.
 - The main gas valve must be installed to allow unobstructed access and complete disconnection of the appliance from the gas supply piping system for servicing purposes. Only install gas shut-off valves approved for use by the state or province where the appliance is being installed or as directed by a the office of local jurisdiction.
 - This appliance is intended for use only with the type of gas indicated on the rating plate. These appliances cannot be converted for use with other gases unless a certified kit is used and the conversion is performed by a qualified service technician.

8.1 Gas connection

Correctly size and route the gas supply line from the supply regulator to the area where the appliance will be located following the requirements outlined in the latest edition of the National Fuel Gas Code, NFPA 54 (USA) or CAN/CSA-B1491 (Canada). Make sure there is no debris in the gas pipes and connections.

Table 8-1: Natural gas pressure requirements

Nominal inlet pressure	7.0 W.C." [1,74 kPa]
Minimum inlet pressure	4.1 W.C." [1,04kPa]
Maximum inlet pressure	10.5 W.C." [2,61 kPa]
Manifold pressure	3.6 W.C." [0,89 kPa]

8.1.1 Gas pressure

To ensure safe and efficient gas appliance operation, it's vital to maintain appropriate gas pressure levels. Verify manifold outlet pressure and adhere to gas line sizing requirements outlined by industry standards before installing approved shut-off valves for optimal safety.

- An optimum appliance performance requires the appropriate input pressures and unobstructed gas flow.
- Gas line sizing requirements must be determined using ANSI Z223.1/NFPA 54 National Fuel Gas Code in the USA and CAN/CGA B149.1 in Canada.
- The manifold outlet pressure is set by the factory to the appropriate pressure but must be verified.
- To check pressures, control valves have a provision to remove a 1/8" NPT plug to be fitted with a hose barb.
- A gas shut-off valve must be located in an accessible location to isolate the gas supply.
- Only install gas shut-off valves approved for use by the state, province, or office of local jurisdiction in which the appliance is being installed.

8.1.2 Gas shut-off valve

Place a gas shut-off valve in the gas pipe in accordance with the applicable regulations. The following requirements apply to the gas connection:

- Flexible gas connectors must not exceed 2 feet in length unless allowed on the basis of local regulations.
- The incoming gas line must be fitted to a $\frac{3}{8}$ " gas inlet port.

8.2 Electrical connection preparation

The appliance must be connected to 120V~ by means of the supplied (24 VDC) adapter. A receptacle must be installed in combination with a provision to ground the appliance. Follow the steps and instructions in this section to achieve this:



DANGER

- The outlet and adapter must be placed outside of the chase. Alternatively they can be placed near to the supply of cool air to guarantee the maximum temperature of 140°F [60°C] cannot be exceeded.



WARNING

- All electrical connections must be properly installed, insulated, and secured to avoid potential **ELECTRICAL SHOCK**, a **FIRE HAZARD**, or a malfunction of the system. Consult local building code requirements. In the absence of local codes, refer to the National Electric Code, ANSI/NFPA 70, or the Canadian Electric Code, CSA C22.1.
- Disconnect the power supply from the mains before servicing any electrical components.
- The grounding wire and electrical cord must be positioned with a minimum clearance of 2" [50mm] from the appliance and have a minimum heat resistance of 176°F [80°C].



CAUTION

- **DO NOT** place batteries inside the receiver. Doing so will cause malfunctions and damage the electronics. The 24V power input provides power to all components.



NOTICE

- Local codes and regulations that are more stringent than the requirements in this manual take precedence over DRU requirements.
- Make sure there is a minimum of 7 7/8" [200mm] of slack in the grounding wire and electrical cord for easy removal and access during future maintenance.

8.2.1 Grounding

For the appliance to function safely and correctly, the appliance must be grounded in accordance with local codes or, in the absence of local codes, with the National Electrical Code, ANSI/NFPA 70, or the Canadian Electrical Code, CSA C22.1. Make a grounding connection between the ground and the dedicated connection point on the appliance (see Fig. 8-1).

- Use 18 AWG stranded wire with a minimum heat resistance of 176°F [80°C] for the grounding wire.
- Crimp a 6.3mm Faston connector to the end of the grounding wire.
- Make sure at least 7 7/8" [200mm] of slack is provided in the grounding wire to allow easy removal during future maintenance.

8.2.2 Power supply

A permanent electrical outlet must be installed inside a suitable junction box that has provisions to accommodate metal-clad cable and/or conduit. The outlet has to be positioned within 78" [200cm] of the electrical components (see Fig. 8-1).

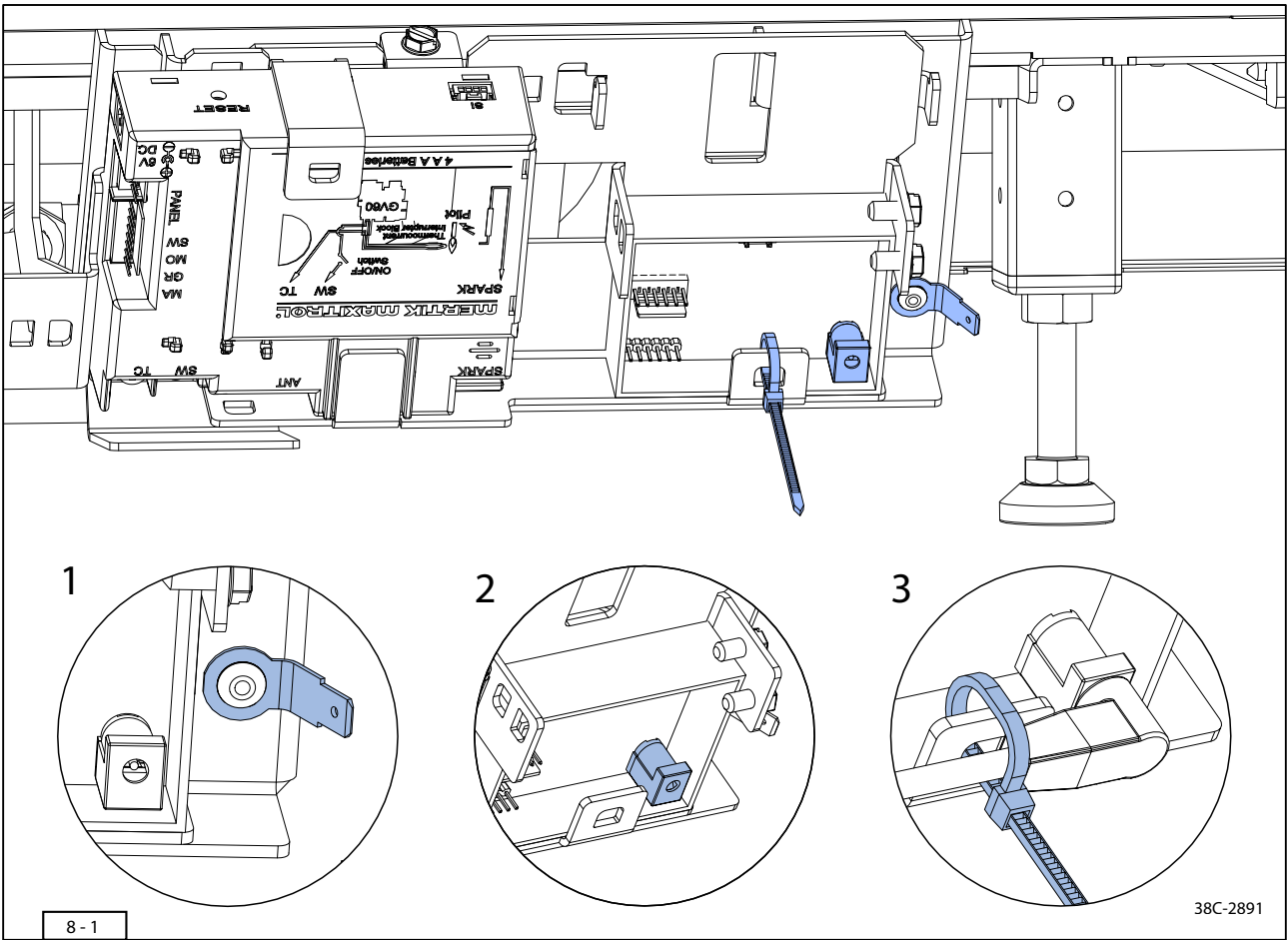

9. Installing and connecting the appliance

Before beginning the installation process, it's crucial to adhere to safety guidelines and manufacturer specifications. Proper gas pipe installation, cable positioning, and component placement indoors are vital for both performance and safety.



WARNING

- Install the gas pipe in accordance with the manufacturer's instructions.
 - Make sure there is a minimum distance of 1" [25mm] between the appliance and the gas hose.
 - Always install the gas hose as low as possible in the chase and maintain at least 7 7/8" [200mm] of clearance from the bottom of the fire.
 - Make sure that the cables under the appliance are as low as possible from the appliance's surface, are free of metal parts and signal and power cables.
- The adjustable feet have an adjustment range of at least 2 9/16" [65mm] to a maximum of 3 1/8" [80mm] (measured from the surface on which the adjustable foot screws into the appliance to the bottom side of the adjustable foot, (see Fig. 9-1). Installing it lower can result in a risk of fire and a shortened service life of the components.
 - Level the surface or build provisions if more adjustment/construction height is required. The use of an alternative/ extended adjustable foot is not allowed.
 - If the adapter or its components are damaged, they should be replaced immediately by an adapter of the same type.
 - The appliance and the appliance control unit should always be placed indoors in a dry location.
 - Prevent the gas pipe, the grounding cable, and the 24V cable from making contact with the appliance. Use a minimum distance of 2" [50mm] for this.
 - Do overnot tighten the connections. Over tightening can damage the control body, resulting in a leak or a control malfunction.
 - When pressure testing the appliance, gas line, and input system, follow the appropriate local codes for your area. To prevent damage to the gas control valve **DO NOT** connect the appliance to pressures in excess of:
Natural Gas: 10.5 W.C." [2,61kPa]
 - The appliance and its appliance main gas valve must be disconnected from the gas supply piping system during any pressure testing of that system at test pressures in excess of 1/2 psi (3.5 kPa). The appliance must be isolated from the gas supply piping system by closing its equipment shutoff valve during any pressure testing of the gas supply piping system at test pressures equal to or less than 1/2 psi (3.5 kPa).



CAUTION

- The use of the Appliance Control Cover is not optional. Not using the Appliance Control Cover and moving the appliance control unit outside of the appliance can result in dangerous situations and voids the warranty.



NOTICE

- The rating plate must remain attached to the appliance by means of the chain provided at all times.
- Provisions for grounding the appliance are not included with the appliance.

9.1 Installing the appliance

When installing the appliance, proceed as follows (see Fig. 9-1):

- 💡 If the appliance is installed higher than $7\frac{7}{8}$ " [200mm] (measured from the surface of the room up to the bottom side of the built-in frame), in accordance with local building regulations, a supporting structure must be made inside the chase on which the appliance must be elevated.

⚠️ WARNING

- A distance of $7\frac{7}{8}$ " [200mm] between the bottom of the appliance to the surface under the appliance must always be guaranteed. This distance is equal to the minimum height of the adjustable feet, $2\frac{9}{16}$ " [65mm].
 - The surface under the appliance must be level so that the minimum construction height is guaranteed over the entire surface.
- Move the appliance from the pallet to the installation location.
 - Use the surfaces of the built-in frame to check whether the appliance is level. If necessary, adjust, using the adjustable feet. Before adjusting the appliance, always start with the right front adjustable foot so that the minimum construction height is guaranteed.
 - Position all cables and hoses as close as possible to the surface under the appliance.

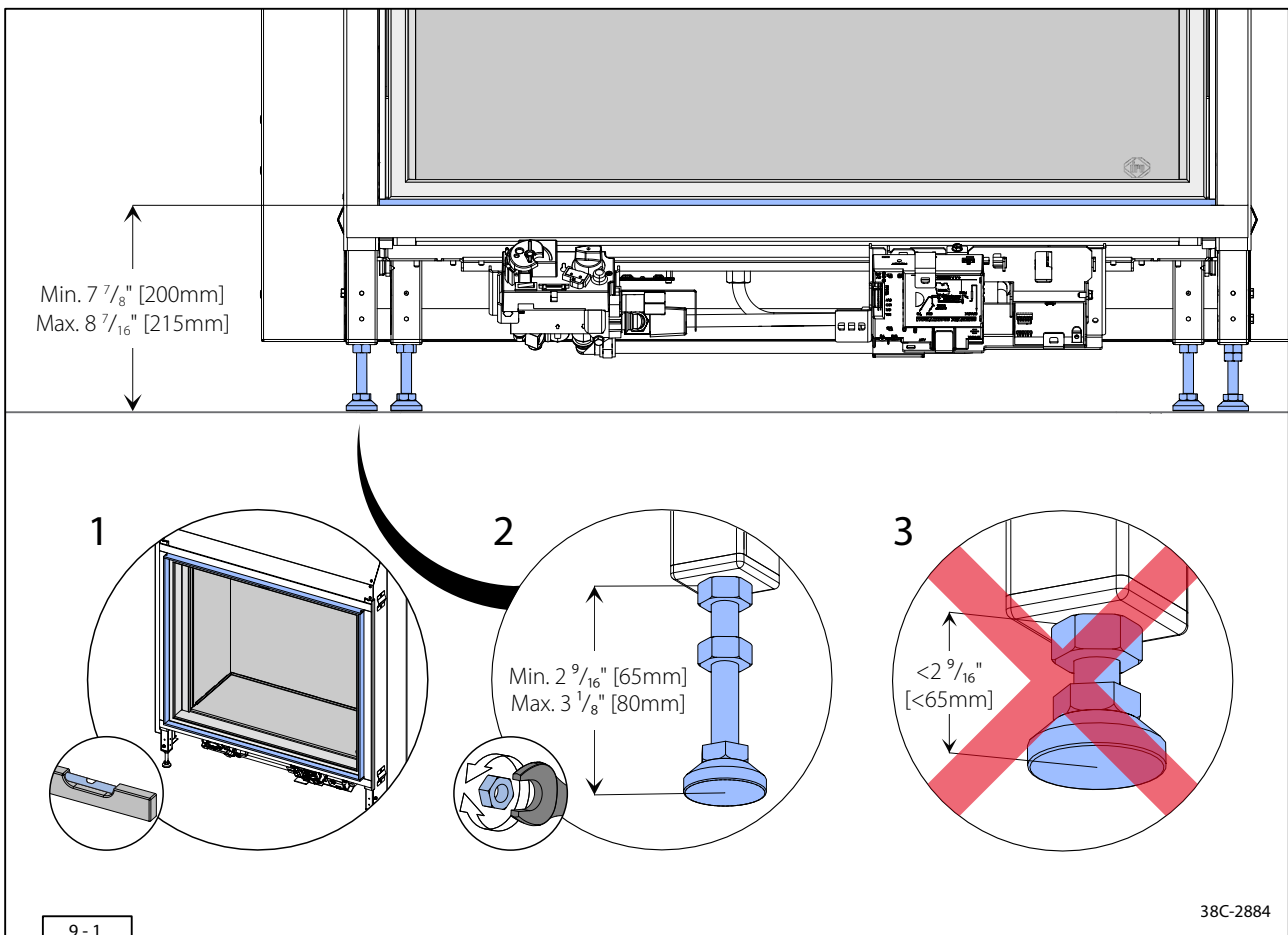

9.2 Connecting the gas supply and electricity

Under the Appliance Control Cover you will find the appliance control unit and the rating plate. The Appliance Control Cover makes the measuring and adjustment facilities accessible and makes sure a safe and optimum operation of the components.



NOTICE

- The rating plate must remain attached to the appliance by means of the chain at all times.
- Connect the components before fully installing the appliance at the front of the chase. By doing this, it is easier to reach the appliance control unit and work on the components.

When connecting the appliance, proceed as follows (see Fig. 9-2):

- Connect the gas pipe to the appliance (Step 1).
- Open the gas shut-off valve and check carefully for gas leaks immediately after the gas pipe has been installed and the gas turned on. Do this before attempting to operate the appliance or other gas burning devices.
- Bleed the system by opening the inlet pressure measuring nipple several turns, allowing the air to escape from the system, and then close the measuring nipple again (Step 2).
- Using a clean brush, apply an approved leak test solution to the tubing and pipe connections. Bubbles indicate a leak.
- If a leak is detected, tighten the pipe connections (including adapters) in accordance with the manufacturer's specifications.
- Ground the appliance by connecting it to the location's grounding circuit with a Faston 6.3 connector (Step 4).
- Connect the appliance to the 120V power supply using the provided 24V adapter (Step 5).
- Fasten the cord of the adapter to the bracket using the provided heat-resistant tie-wrap (Step 6).

- Remove the rating plate from the appliance (Step 7).
- Place the rating plate on the floor to the left under the appliance (Step 8).

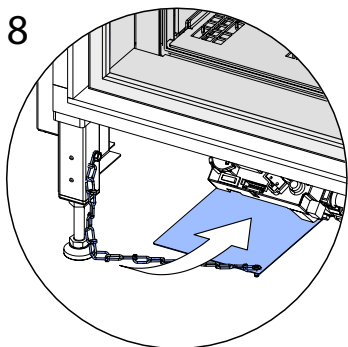
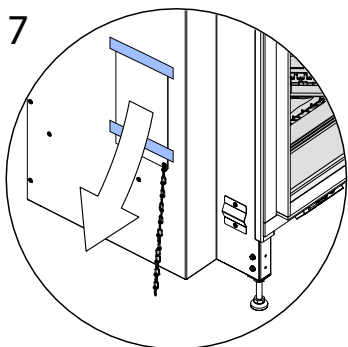
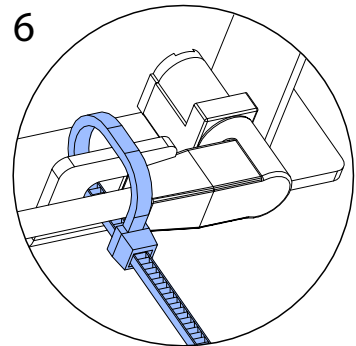
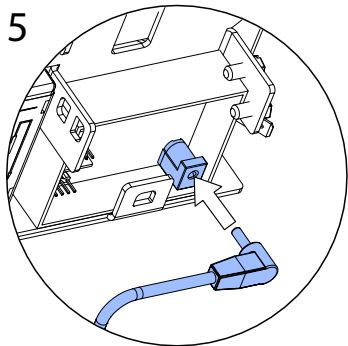
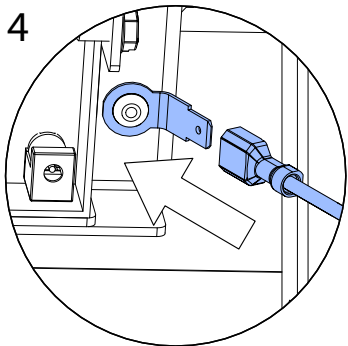
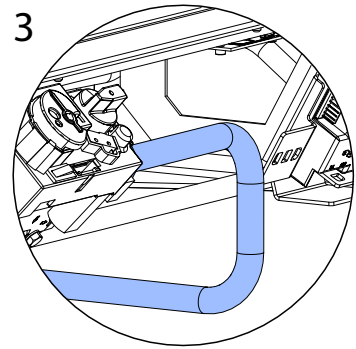
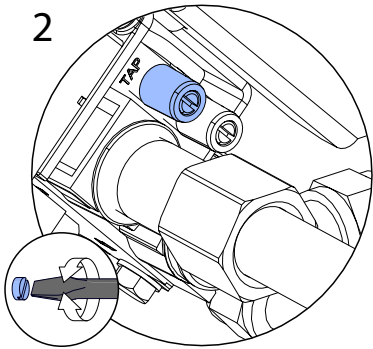
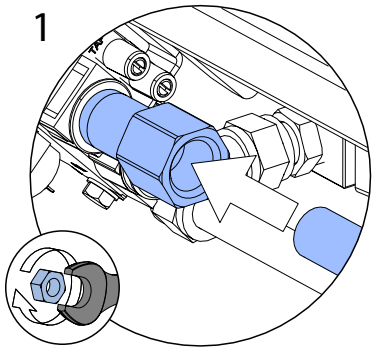
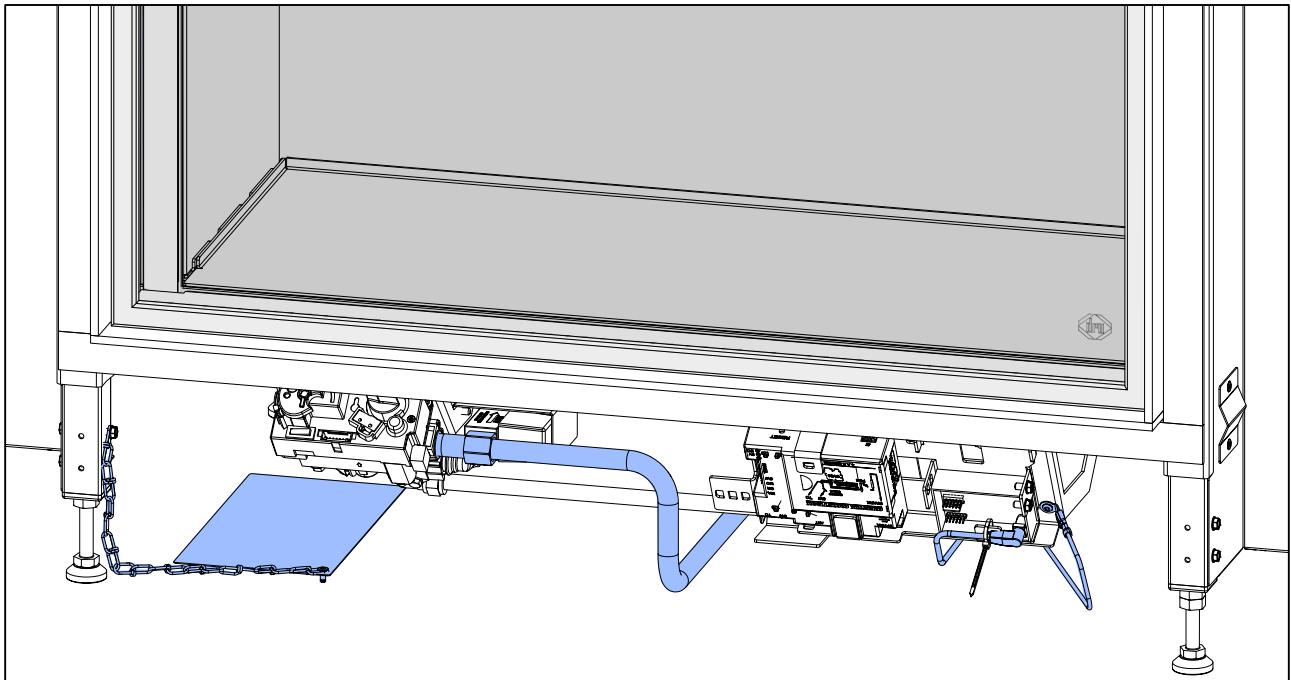

9.2.1 Check gas supply pressure

The supply pressure needs to be checked. Follow the steps below (see Fig. 9-3):

- Confirm the main gas supply line is closed.
- Remove the Micro Mesh Screen, the Appliance Control Cover and the door from the appliance.
- Open the valve of the supply pressure measuring nipple a few turns with a flat-head screwdriver and connect the pressure gauge (see Fig. 9-3, (1)).
- Open the main gas supply and check the static supply pressure (see Table 8-1 of the installation manual).
- ⚠ If there is deviation: check the pressure at the gas meter. Contact the gas company if the supply pressure is too high or too low at the gas meter.
- Close the main gas supply.
- Disconnect the pressure gauge and close the valve of the supply pressure measuring nipple (1).

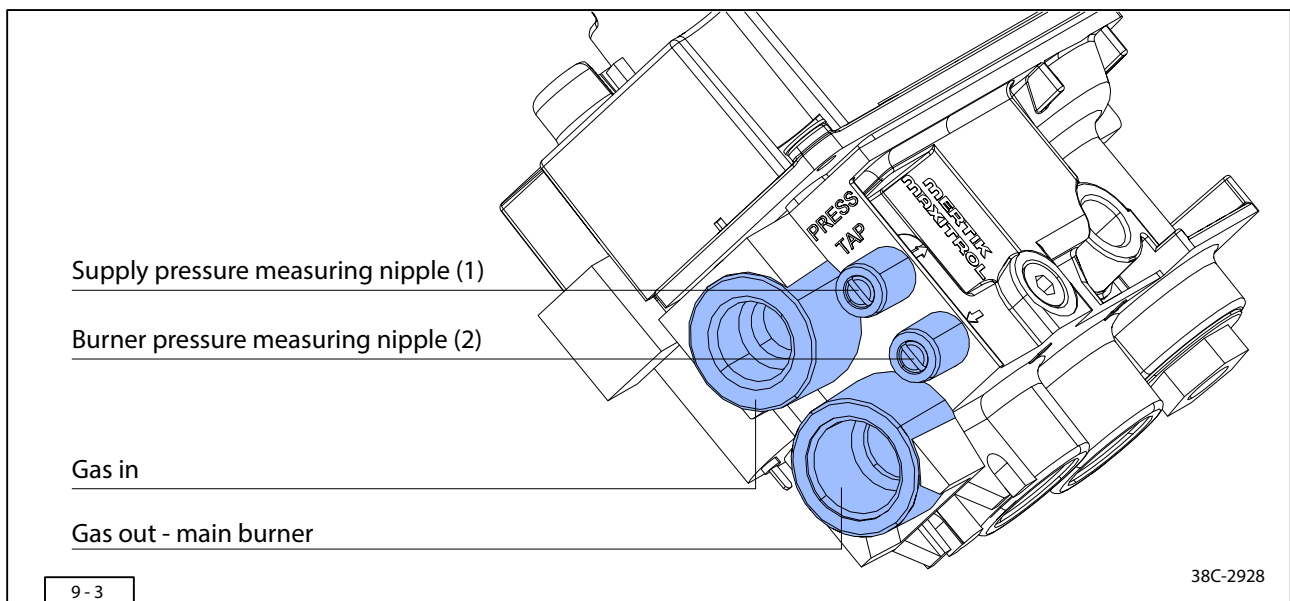

10. Venting

10.1 General venting requirements

The appliance operates using a direct vent system and requires 5"/8" coaxial direct vent pipe (5" [127mm] interior, 8" [203mm] exterior). The inner pipe vents combustion products to the outside while the outer pipe draws in outside combustion air. The flue gases are discharged to the outside by means of natural draft, which can be achieved using a horizontal (see Section 10.2.3) or a vertical (see Section 10.2.2) termination cap.

The appliance must be properly connected to a DRU-approved vent system. Venting is not provided with the appliance and must be sourced from one of the approved vent manufacturers mentioned in Table 10-1. These systems have been tested in combination with the appliance. DRU cannot guarantee a correct and safe operation when using non-approved systems and does not accept any responsibility or liability for this.

Correct installation, use, and maintenance of venting is determined by and can be obtained from the vent manufacturer.

Table 10-1: Approved vent systems*

Manufacturer	Series
DuraVent	DirectVent Pro (58DVA series)
Selkirk	Direct-Temp System (SDT series)
BDM	Pro Form Direct vent system (DVR8 series)

* Refer to Appendix D for a list of approved wall and roof terminals as not all are approved for use with this appliance.



WARNING

- The 5"/8" coaxial vent collar is designed to be fitted directly onto the DuraVent DirectVent Pro venting system. Follow the supplier's instructions to connect to the Selkirk Direct-Temp system or the BDM Pro Form Direct vent system.
- The gas appliance and vent system must be vented directly to the outside of the building and may never be attached to a chimney serving a separate solid fuel or gas burning appliance. Each direct vent gas appliance must use its own separate vent system. Common vent systems are prohibited.
- This appliance cannot be connected to an existing chimney.
- Do not combine vent components from different vent manufacturers. Follow the manufacturer's instructions for vent system installation.
- Perform a check on the vent system to verify proper and unobstructed airflow after finishing the vent installation.



NOTICE

Refer to your building envelope engineer or waterproofing consultant for a review of **ALL** penetrations through exterior walls or the roof.

10.2 Vent configurations

The direct vent termination location **MUST** be the highest point in the venting assembly. It must provide the shortest vent run possible without any negative angles.



WARNING

A negative angle in the flue system is **NOT** allowed.

Take the following into account when planning the venting layout:

- Venting originates from the top of the unit
- Venting can terminate through the roof (with a vertical termination cap) or through an exterior wall (with a horizontal termination cap).
- The draft hood be installed so as to be in the same atmospheric pressure zone as the combustion air inlet to the appliance and shall be located so that the relief opening is accessible for checking vent operation.
- Refer to the corresponding sections in this chapter to be sure that the planned termination location is acceptable.

Once the termination location has been determined, refer to the appropriate section below for installation details.

My Flue Assist is a DRU web application to check whether an intended concentric system is permissible and provides advice on how to adjust the appliance. The information supplied in the installation manual always takes precedence.



Scan the QR code to visit the MY FLUE ASSIST tool at www.druservice.us

10.2.1 Definition of horizontal and vertical vent layout

There are specific requirements for horizontal and vertical venting installations. It is critical to stay within the venting profile below when calculating the horizontal run and the vertical rise with the vent pipe. In the next section the total length of the vent system is calculated. Offset distances are calculated from the vent collar on the appliance (see Fig.10-1)

Vertical (V): All lengths with an angle between 90° (true vertical) and 45°.

Horizontal (H): All lengths with an angle between 0° (true horizontal) and 44° count as a horizontal vent.

- Example:
- The 3' [1m] sections of 30° must be counted as 9' [3m] of horizontal vent length.
 - Two 3' [1m] sections of 45° must be counted as 6' [2m] of vertical vent length.

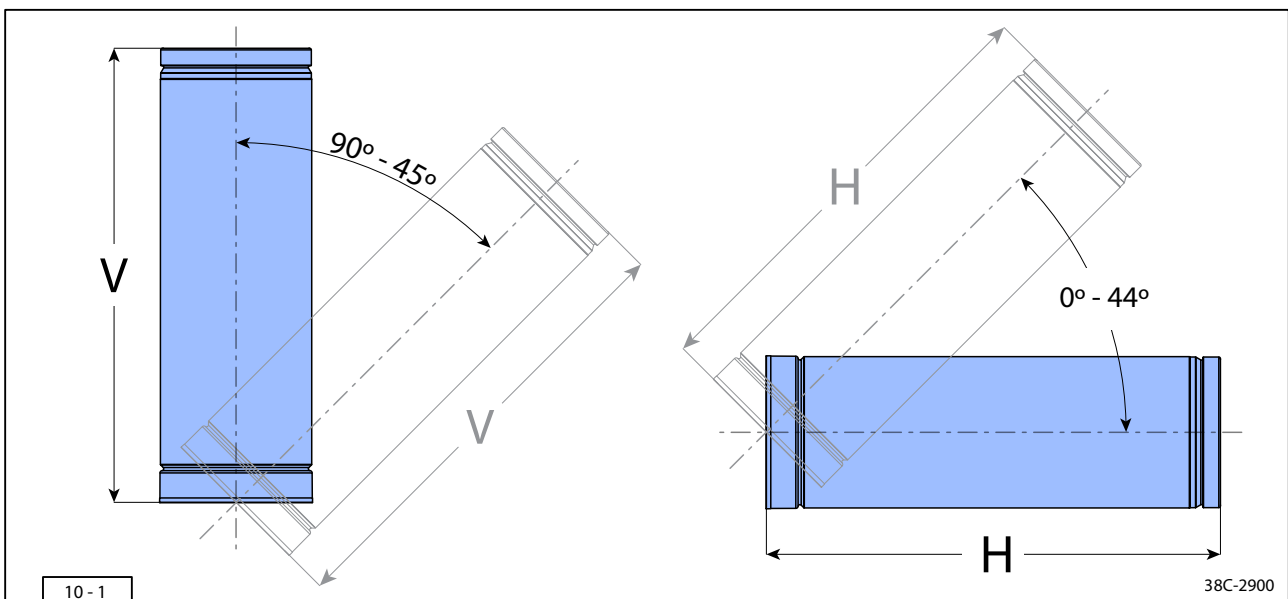

V = Linear vertical vent length.

H = Linear horizontal vent length.

10.2.2 Vent system with vertical termination cap (roof terminal)

The vertical termination cap can be used in combination with either a sloping or flat roof. Check with the vent-system manufacturer for suitable flashing options. The layout of the chosen vent system must be approved. The working method below indicates how the permissibility of a concentric system is determined when using a roof terminal. Check by following the steps below:



WARNING

- At least 3' [1m] of vent pipe must **ALWAYS** be placed on the appliance vertically before using any offsets, unless stated otherwise.
- Check if the installation is allowed with regard to clearances to combustibile materials.
- The vent termination must be kept clear of snow, vegetation or any other source of potential blockage.

- Sketch the intended vent configuration on paper. In the sketch, include the layout, linear lengths, and offsets (including degree of angle). Use this sketch for the following steps:
- Count and write down the number of 45°, 60°, and 90° offsets (30° offsets are allowed but do not count).
- Add up and write down the total length of horizontal vent pipe length as defined in Section 10.2.1.
- Add up and write down the total length of the vertical vent pipe length as defined in Section 10.2.1.

Use Figure 10-2 to check if the configuration is allowed and for the relevant appliance settings:

- Select one of the four graphs with the corresponding number of offsets (1, 2, 3, or 4).
- Use the calculated horizontal and vertical lengths as calculated above. Find the plane where these lengths intersect on the selected graph.
- A letter indicates if the vent set-up is allowed. All options other than shown are **NOT** allowed. Reconfigure the layout.
- Use the letter to find the relevant setup for the vent system (see Table 10-2).
- See Table 10-2 for the appliance settings of the configuration selected: Remove or replace the air inlet guides, if necessary, and remove/adjust the restrictor slide.

Table 10-2: Vertical termination (roof terminal) settings

	Restrictor slide	Restrictor slide setting*	Air inlet guide
A	No	N.A.	None
B	Yes	2 3/4" [70mm]	Low (7/16" [11mm])
C	Yes	2 1/16" [53mm]	Low (7/16" [11mm])
D	Yes	1 9/16" [40mm]	Low (7/16" [11mm])

*Adjust the restrictor slide to the corresponding letter.

FOR USE WITH NATURAL GAS ONLY

V = Vertical vent height in feet [meters]. H = Horizontal vent length in feet [meters]

Vent layouts are for demonstration purposes only.

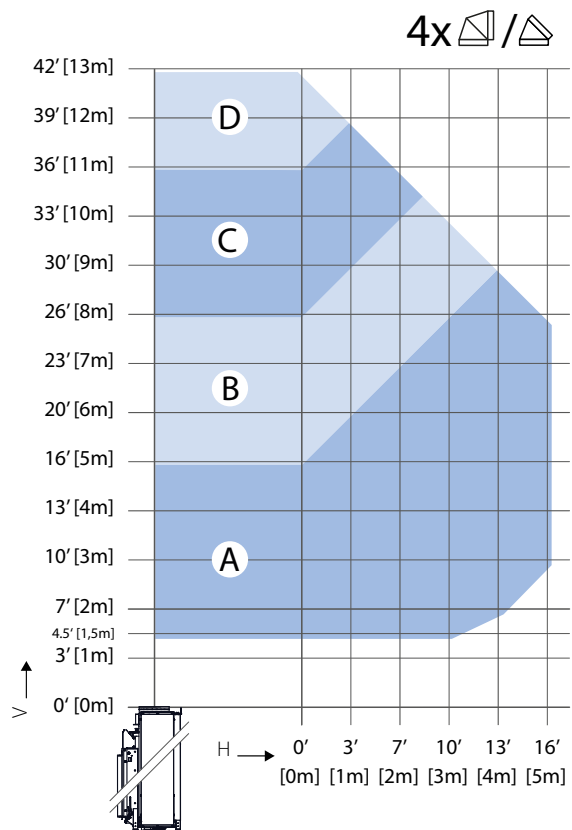
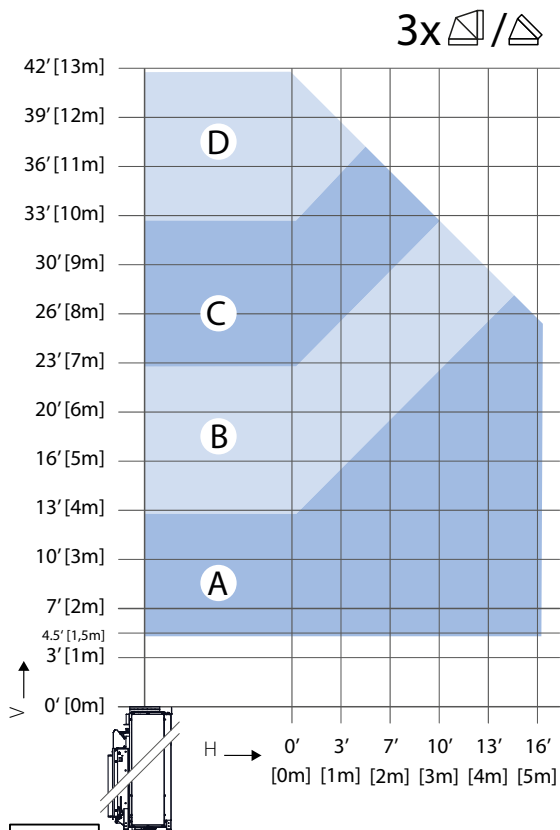
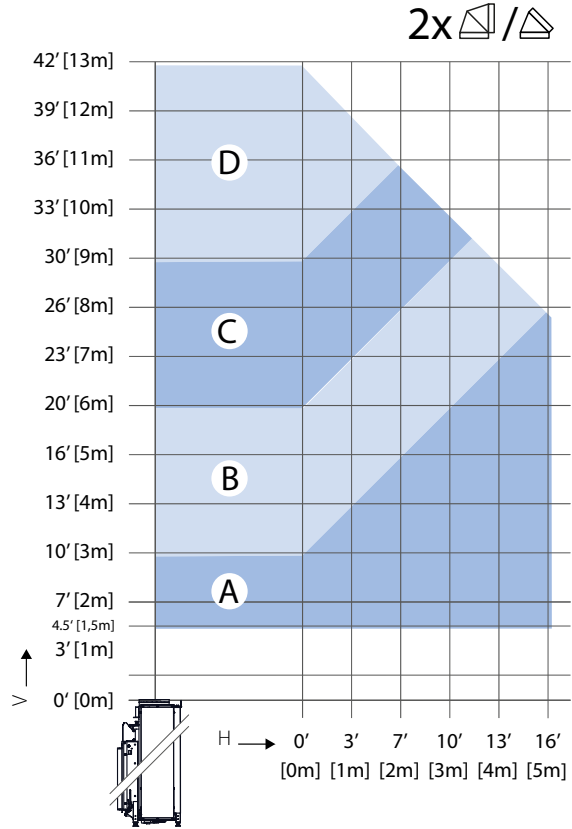
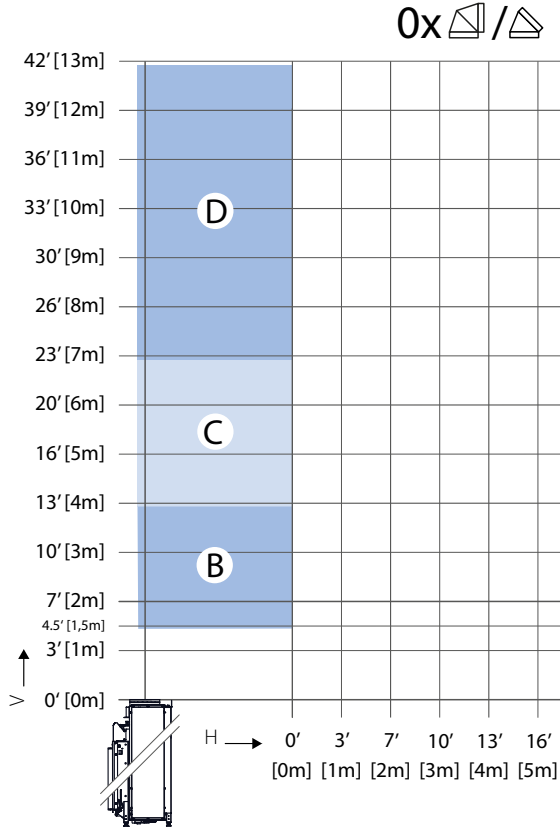

10.2.3 Vent system with horizontal termination cap (wall terminal)

The layout of the chosen vent system must be approved. Follow the steps below when using a horizontal termination cap:



WARNING

- At least 1.5' [0,5m] of vent pipe must **ALWAYS** be placed on the appliance vertically before using any offsets, unless stated otherwise.
- Check if the installation is allowed with regard to clearances to combustibile materials.
- The vent termination must be kept clear of snow, vegetation or any other source of potential blockage.

- Sketch the intended vent configuration on paper. In the sketch, include the layout, linear lengths, and offsets (including degree of angle) (see the example, Fig. 9-3). Use this sketch for the following Steps:
- Count and write down the number of 45°, 60°, and 90° offsets after the first offset (30° offsets are allowed but do not count).
- Add up and write down the total length of the vertical vent pipe length as defined in Section 10.2.1.
- Add up and write down the total length of horizontal vent pipe length as defined in Section 10.2.1.

ONLY follow the next step if more than 1 offset is used in the vent configuration:

- 💡 In both Fig. x-x and Table x-x, 1 offset has been accounted for but more may be added. Each additional offset adds extra drag to the system and must therefore be accounted for.
- - For each additional 90° offset, add 6.5' [2m] to the horizontal length calculated in the next step.
- - For each additional 45° and 60° offset, add 3' [1m] to the horizontal length calculated in the next step.

Use Figure10-4 to check if the configuration is allowed and for the relevant appliance settings:

- Use the horizontal and vertical lengths as calculated in the steps above. Find the plane where these lengths intersect on the selected graph.
- A letter indicates if the vent set-up is allowed. All options other than shown are **NOT** allowed. Reconfigure the layout.
- Use the letter to find the relevant setup for the vent system (see Table 10-3).
- See Table 10-3 for the appliance setting of the configuration selected: Remove the air inlet guides, if necessary.

Calculation example based on the vent configuration sketch of Fig. 10-4:

- Total linear vertical length: 3' [1m] + 5' [1,5m] = **8' [2,5m]**
- Total number of offsets after the first offset (the first offset is not included in the calculations): **2 x 90°**.
- Extra horizontal length as compensation for the second and third offset: 2x 6.5' [2m] = **13' [4m]**.
- Total linear horizontal length: 13' [4m] (two extra offsets) + 3' [1m] + 1.5' [0,5m] = **18' [5,5m]**
- This configuration ends up on plane C in Fig. 9-4 (8' [2,5m] vertically x 18' [5,5m] horizontally).
- See Table 10-3, configuration C: Remove the air inlet guides from the appliance.

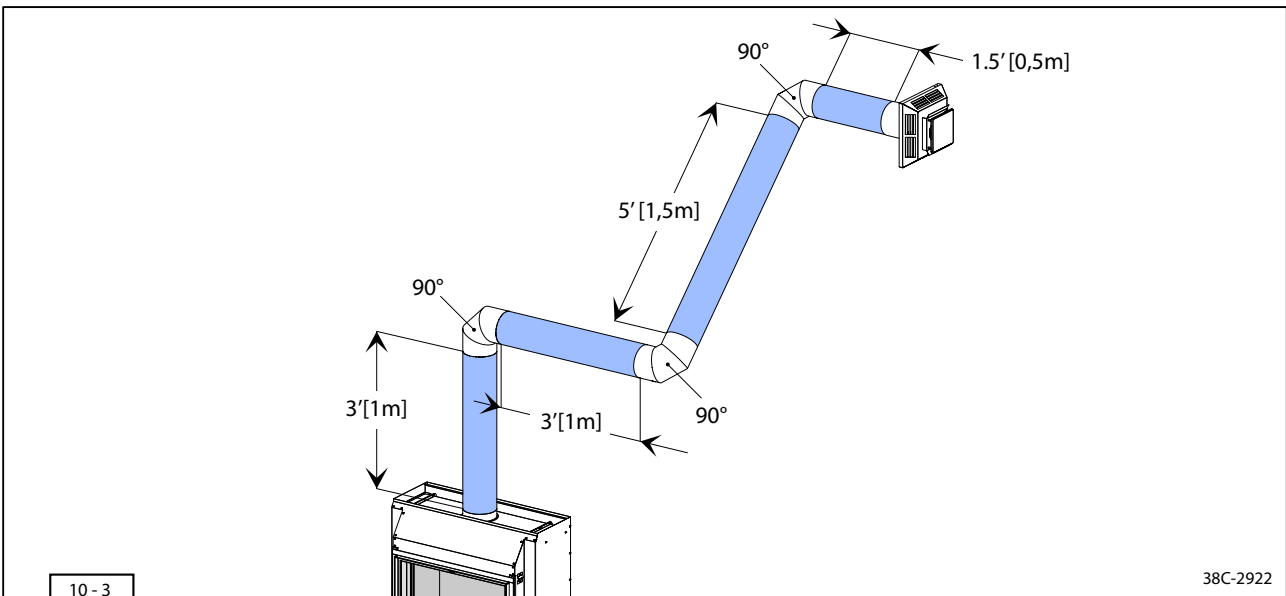

Table 10-3: Wall terminal settings - Natural Gas

	Vertical ft[m]	Horizontal ft[m]	*Restrictor slide	*Air inlet guide
B	0 - 2' [0 - 0,6m]	7 7/8" [0,2m]	1 15/16" [74mm]	None
A¹	2' - 4 1/4' [0,6 - 1,3m]	3' - 10' [1 - 3m]	None	High (3/4" [20mm])
A²	2' - 4 1/4' [0,6 - 1,3m]	10' - 16' [3 - 5m]	None	None

*Factory settings: Air inlet guide installed. The restrictor slide is supplied separately with the appliance.

FOR USE WITH NATURAL GAS ONLY

V = Vertical vent height in feet [meters]. **H** = Horizontal vent length in feet [meters]

Vent layouts are for demonstration purposes only.

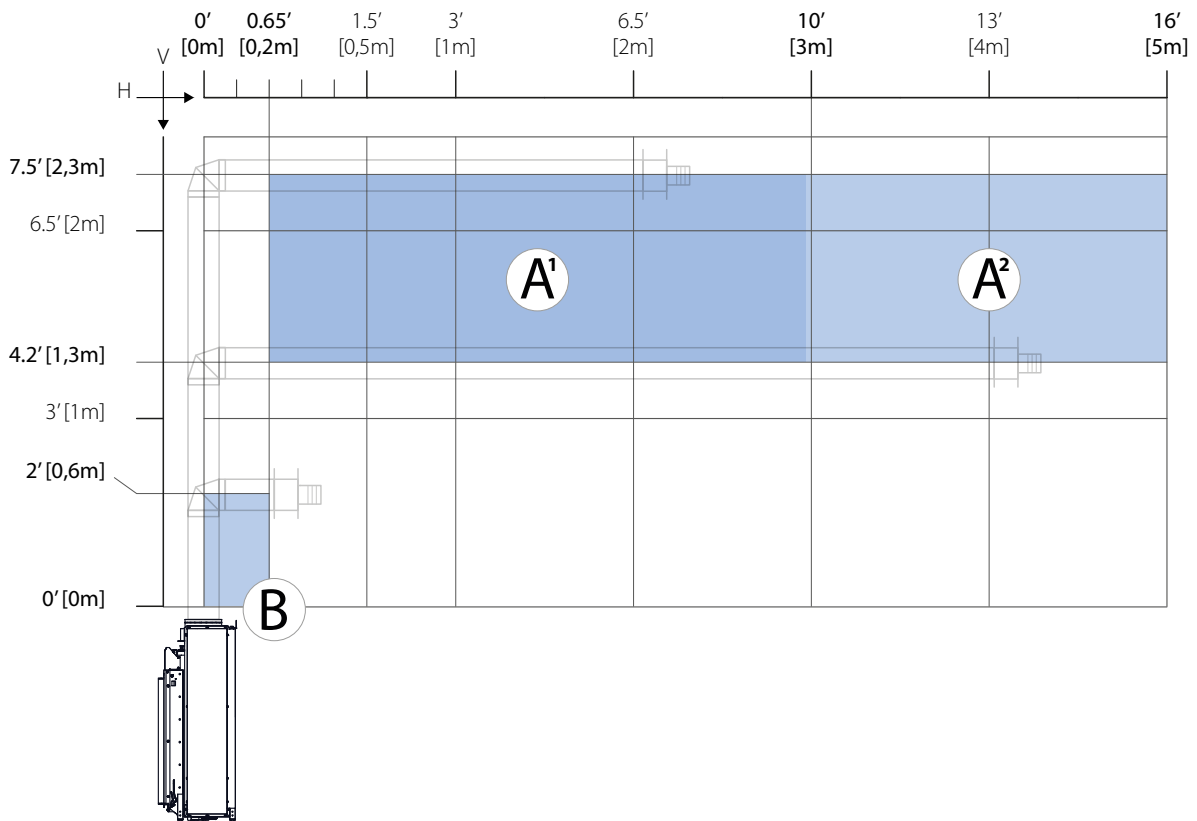

10.3 Clearances to the vent system

The minimum clearances to the vent pipes apply regardless of the vent manufacturer unless specified otherwise (See Fig. 10-5):

- **Sides** 1" [25mm] Applies to entire circumference when venting is oriented vertically. Clearance is to any material.
- **Top*** 3" [75mm] Applies to venting oriented horizontally or at an angle. Clearance is to any material.
- **Bottom** 1" [25mm] Applies to venting oriented horizontally or at an angle. Clearance is to any material.

*Exception: Wall thimble top clearance to any material is 1" [25mm].

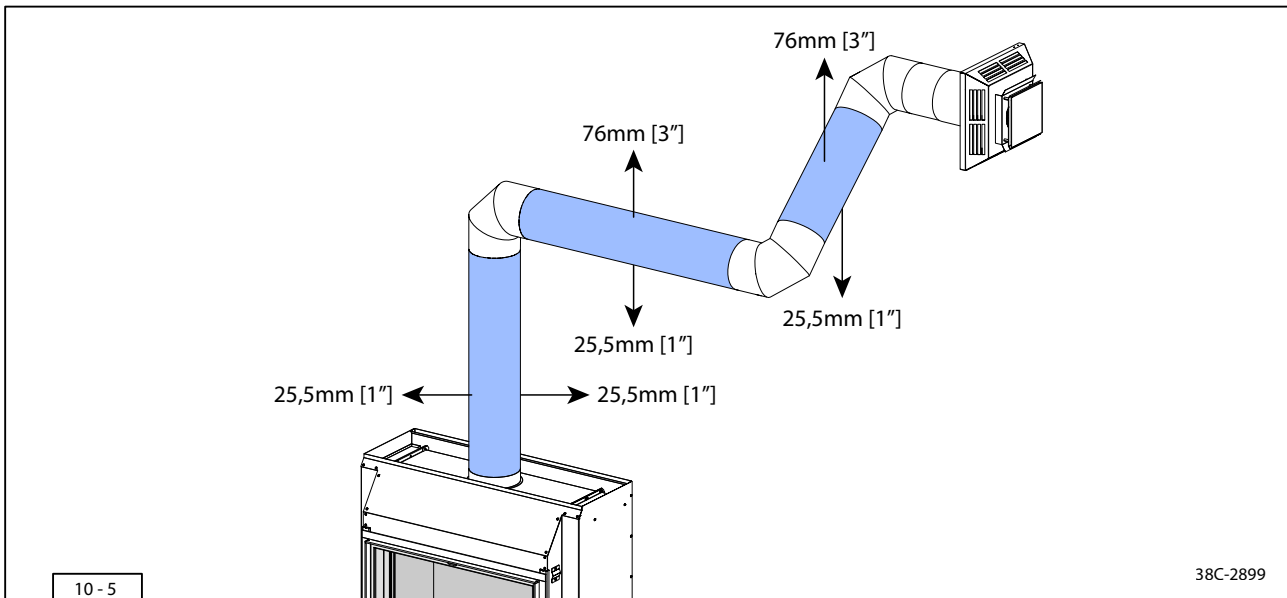

10.3.1 Clearances for installations with a horizontal termination cap

Follow the instructions and measurements as described in this section:



WARNING

- If exterior walls are finished with a vinyl siding, a vinyl protector kit must be installed.
- A vent system termination is not permitted in screened porches.
- A vent system termination is permitted in porch areas with two or more sides that are open. You must follow all side walls, overhang and ground clearances as stated.
- Termination cap may be hot. Consider its proximity to doors or other traffic areas.

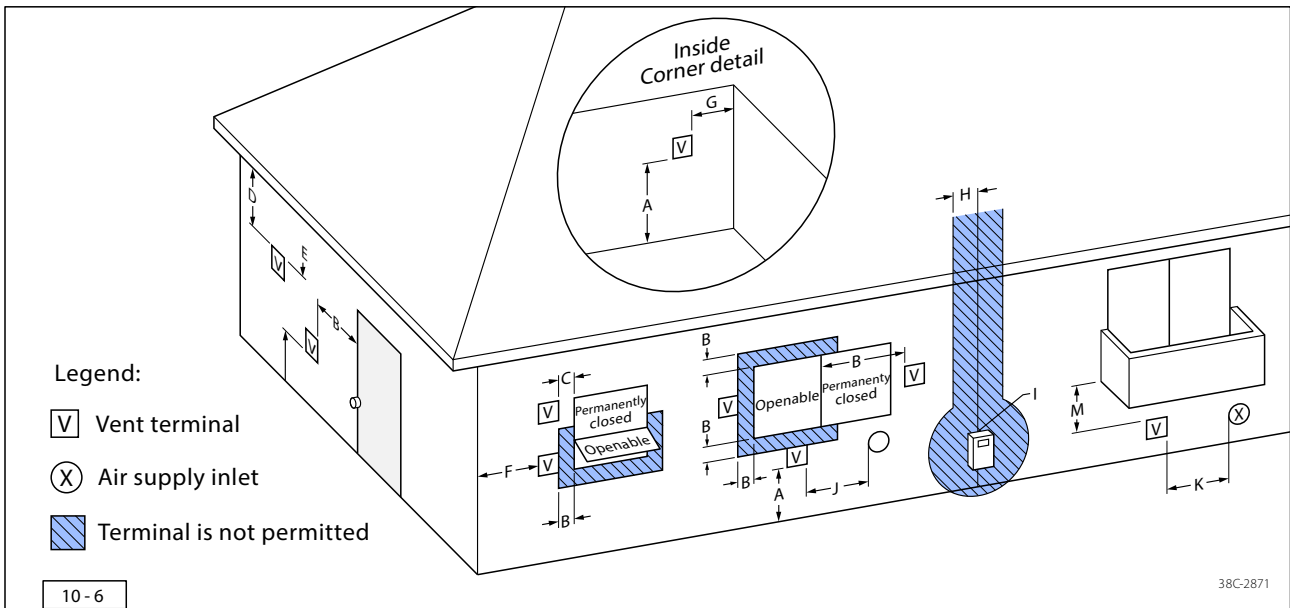

Table 10-4: Wall terminal clearances

Location	Canada*	USA**
A Clearance above the grade, veranda, porch, deck, or balcony	12" [30cm]	12" [30cm]
B Clearance to a window or door that may be opened	12" [30cm]	9" [23cm]
C Clearance to a permanently closed window	*	*
D Vertical clearance to a ventilated soffit located above the terminal within a horizontal distance of 2 feet/61cm from the center line of the terminal	25" [65cm]	25" [65cm]
E Clearance to an unventilated soffit	24" [61cm]	20" [51cm]
F Clearance to the outside corner	9" [23cm]	6" [15cm]
G Clearance to the inside corner	9" [23cm]	6" [15cm]
H Clearance to each side of the center line extended above a meter/regulator assembly	3ft [91cm] within a height 15ft [4,5m] above the meter/ regulator assembly	*
I Clearance to the service regulator vent outlet	12" [91cm]	*
J Clearance to the nonmechanical air supply inlet to the building or the combustion air inlet to any other appliance	12" [30cm]	9" [23cm]
K Clearance to a mechanical air supply inlet	72" [180cm]	12" [91cm] above if within 120" [300cm] horizontally
L Clearance above a paved sidewalk or paved driveway located on public property	84" [213cm] †	*
M Clearance under a veranda, porch deck, or balcony	12" [30cm] ‡	*

*) Clearance in accordance with local installation codes and the requirements of the gas supplier.

† A vent must not terminate directly above a sidewalk or paved driveway that is located between two single family dwellings and serves both dwellings.

‡ Permitted only if the veranda, porch, deck, or balcony is fully open on a minimum of two sides beneath the floor.

10.3.2 Clearances for installations with a vertical termination cap

Follow the instructions and measurements as described in this section:



WARNING

- The minimal distance H shown in Fig. 10-7 may vary depending on regional snowfall. Refer to local codes.
- Maintain a minimum of 2" clearance between edge of vertical termination and perpendicular wall
- If terminating near a window: keep a minimum of 2' of clearance to vent termination.
- All mechanical air intakes within 10' of a gas termination cap must be a minimum of 3' below the gas termination cap.
- All gravity air intakes within 3' of a gas termination cap must be a minimum of 1' below the gas termination cap.



Use fig. 10-7 in conjunction with Table 10-5 to determine the height of the vertical termination cap.



Maintain the clearances as shown in Fig. 10-7 when constructing an overhang over the vertical termination cap.

Table 10-5: Clearances	
Roof pitch	Min. Height
Flat to 7/12	1' [30cm]
Over 7/12 to 8/12	1.5' [45cm]
Over 8/12 to 9/12	2' [60cm]
Over 9/12 to 10/12	2.5' [75cm]
Over 10/12 to 11/12	3.25' [100cm]
Over 11/12 to 12/12	4' [120cm]
Over 12/12 to 14/12	5' [150cm]

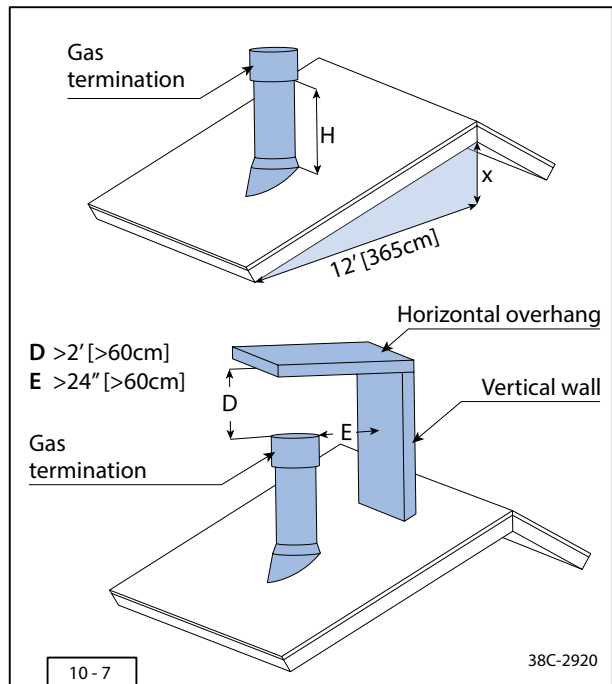

Maintain the specified clearances when multiple vertical termination caps are in close proximity to each other (See Fig. 10-8 and Table 10-6).



WARNING

- When using a decorative cap cover distance A shown in Fig.10-8 may need to be increased. Refer to the installation instructions supplied with the decorative cap cover.
- In a staggered installation with both gas and wood/fuel oil terminations the gas termination must always be placed below the wood/oil termination cap.

Table 10-6: Staggered clearances	
A	B
< 6" [< 150mm]	Not allowed
6" - 24" [150 - 600mm]	> 18" [> 450mm]
>24" [> 600mm]	> 0" [> 0mm]

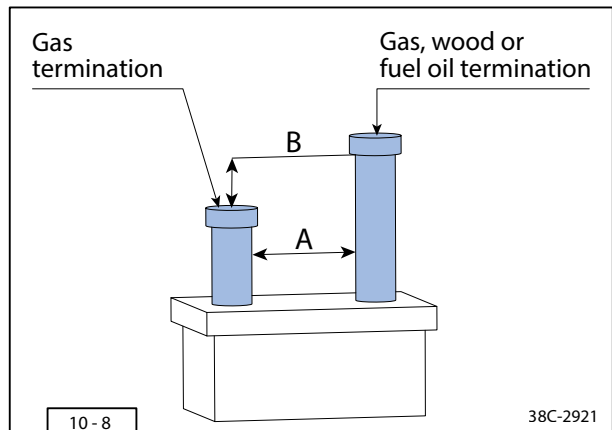

10.4 Vent Installation

Venting must be installed to meet the requirements as detailed in the following sections in combination with the vent system manufacturer's installation instructions.

10.4.1 Permitted components

Understanding permitted components is vital for a safe and effective vent system installation. Follow as described below:



WARNING

- **NEVER** combine vent components made by different vent manufacturers.
- Use of a snorkel termination is **NOT** permitted.
- Reducing the vent system to smaller diameters is **NOT** permitted.
- Gaskets or sealants are **NOT** required (unless specified by the vent system manufacturer).
- Use mill-Pac sealant if sealing is required by the vent manufacturer or local code. **DO NOT** use silicone.
- Conversion from coaxial to co-linear is **NOT** permitted.

ONLY the vent systems listed below are permitted to be used with this appliance*:

- DuraVent DirectVent Pro (58DVA series)
- Selkirk Direct-Temp System (5DT series)
- BDM Pro Form Direct vent system (DVR8 series)

* Refer to Appendix D for a list of approved wall and roof terminals as not all are approved for use with this appliance.

10.4.2 Firestop and wall thimble

When it comes to firestop and wall thimble installation, specific guidelines ensure safety and compliance.



WARNING

- Firestops are required at each floor level beyond the first-floor ceiling support/wall thimble cover or cathedral ceiling support box.
- The first venting section must be secured to the appliance starter collar with a minimum of 3 sheetmetal screws no longer than ½" [12,5mm].
- An attic insulation shield is required in the attic.

10.4.3 Support and fastening

When it comes to supporting and fastening your venting system, strict adherence to guidelines is crucial for safety and stability.



WARNING

- The venting must be supported by the structural surrounding and not by the appliance.
- For appropriate support, use elbow straps with offsets to reduce movement and prevent possible disconnection.
- Use wall straps for long vertical or horizontal runs and at offsets to secure and support the vent pipe.
- Place the first fastening bracket 1.5' [450mm] from the appliance at most.
- Place a fastening bracket at 0.3' [90mm] from each offset if the offsets are more than 0.75' [230mm] away from each other. If two offsets are closer together than 0.75' [230mm], 1 fastening bracket between these offsets will be sufficient.
- Use roof support brackets where needed.
- If an offset is required to avoid obstructions, use a pair of 45° offsets.

- Horizontal/Slanted portions of the venting system shall:
 - Be supported at least every 3.5' [1075mm].
 - Slope upwards not less than ¼ in/ft (21 mm/m) from the appliance to the vent terminal.

- Vertical portions of the venting system shall:
 - Be supported at least every 6.5' [2000mm], place a fastening bracket at vertical sections.

10.5 Chase construction

Before beginning construction of the chase, it's essential to understand the guidelines and precautions outlined in this section. Pay close attention to local building codes, framing requirements, finishing materials, and clearance specifications to ensure a safe and compliant installation:



DANGER

- Before closing off the chase with finishing materials thoroughly inspect the top of the appliance and inside the zero-clearance shell. Remove loose and unwanted materials if needed. Any (building)materials left on top of the appliance can prevent the pressure relief system to function properly.



WARNING

- When the appliance is installed directly on **ANY** combustible material other than wood flooring (carpet, vinyl, etc.), it must be installed on a wooden or metal panel. This material must extend the full width and depth of the appliance.



NOTICE

- Clearances must be in accordance with local installation codes and the requirements of the gas supplier.
- The appliance must be fully enclosed while maintaining clearances to combustibles as detailed in this manual.
- In this chapter, 3.5" x 1.5" [89 x 38 mm] structural lumber has been used for the construction of the chase. It is permitted to use other sizes of structural material, provided that the material meets the specifications and requirements as described in this chapter.

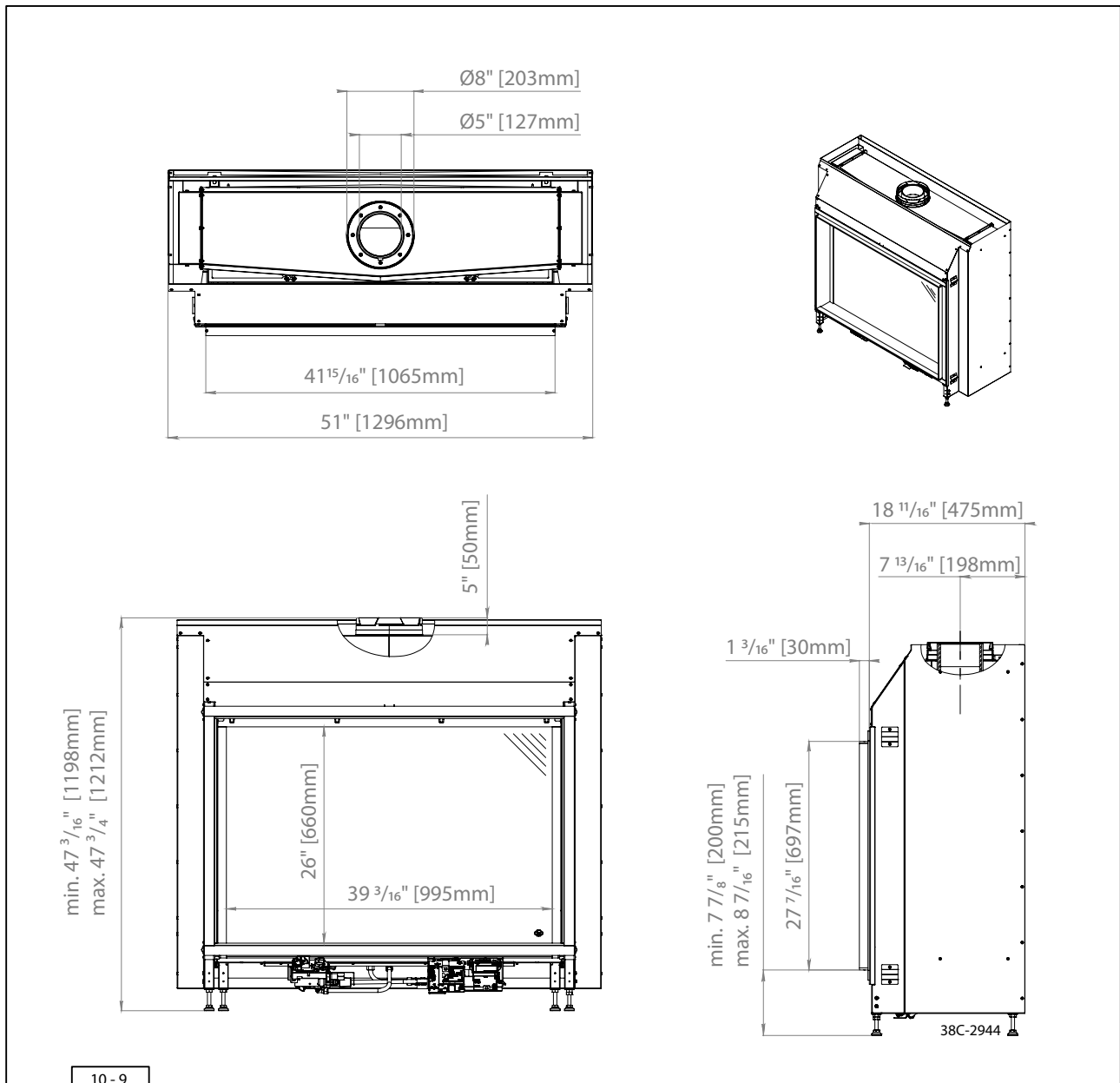

10.5.1 Zero-clearance shell

The appliance features a zero-clearance shell that guarantees a safe distance to the chase's construction materials. The zero-clearance shell allows for direct contact with combustible framing materials on the side and rear of the appliance whereas the front of the chase must be finished with non-combustible building materials. Follow the directions in this chapter carefully and make sure to comply with local building codes during construction.

10.5.2 Framing and finishing requirements

The chase framing may be constructed with either combustible materials such as wood studs or non-combustible materials such as metal studs. The framing must be selected and constructed in such a way that it is suitable for bearing the combined weight of the chase's finishing materials.

The materials listed below **MUST** be used for the chase finishing regardless of whether combustible or non-combustible framing materials are used:

- **SIDE** and **REAR** panels may be constructed with combustible materials:
 - Type X Drywall $\frac{5}{8}$ "
 - Plywood/Underlayment
- **FRONT** panel **MUST** be constructed with non-combustible materials:
 - Cementboard



WARNING

- The top side of the appliance beyond the vertical lip on the angled front panel must remain free of any materials at all times. No materials between the top of the appliance and inside the chase top may be placed inside the marked area (see Fig. 10-10).
- None of the construction materials must make contact or transfer weight onto the appliance or its components nor is it permitted to directly screw, glue, or attach anything in any form onto the appliance, including the zero-clearance shell.
- A heat-resistant firestop is required at the top of the chase to guarantee a safe distance between the flue system and the materials surrounding it. Refer to the catalog of the manufacturer of the flue system for options.
- The chase framing and finishing materials must remain within the depth of the built-in frame. The framing and finishing around the built-in frame must be constructed in such a way that there is a gap of $\frac{1}{8}$ " [2mm] between the built-in frame and the construction materials. This gap allows for the unobstructed expansion of the appliance while in use without damaging the chase and/or appliance itself (see Fig. 10-10, detail A).

10.5.3 Chase platform

The minimum permitted elevated position of the appliance is $7\frac{7}{8}$ " [200mm] (measured from the flooring surface below to the underside of the built-in frame). Altering, cutting, lengthening, or changing the leveling feet is not permitted. If the maximum height is not sufficient for the placement envisioned, a stable and elevated platform must be built inside the chase for the appliance to be placed on. This platform must be flat, solid, and continuous and must be constructed of any suitable building material such as wood, concrete, metal, or any other common construction material of this type.



NOTICE

Take air intake into account when constructing an elevated platform. Either make sure the air intake is located above platform or construct sufficient openings to make sure that at least the equivalent of the minimum specified air intake surface as shown in Fig. 10-11 so that no loss of airflow can occur inside the chase.

10.5.4 Minimum framing dimensions

There are multiple options for the size and design of the chase and framing. The framing must always comply with the minimum and maximum dimensions specified (see Fig. 10-10).

The chase framing and finishing materials must remain within the depth of the construction frame (see Fig. 10-10, Region A). The framing and finishing around the built-in frame must be constructed in such a way that there is a gap of $\frac{1}{8}$ " [2mm] (see Fig. 10-11, detail A) between the construction frame and the construction materials. This gap allows for an unobstructed expansion of the appliance while in use without damaging the chase and/or appliance itself (see Figs. 10-10 and 10-11).



WARNING

- The top side of the appliance beyond the vertical lip on the angled panel must remain completely free of any materials at all times. No building materials may be placed in this area between the appliance and the top of the chase (see Fig. 10-10, Region A).
- This appliance features a built-in pressure relief system located inside the zero-clearance shell. To guarantee proper operation, the space above the appliance must remain free of any (building) materials at all times (see Fig. 10-10, Region A).

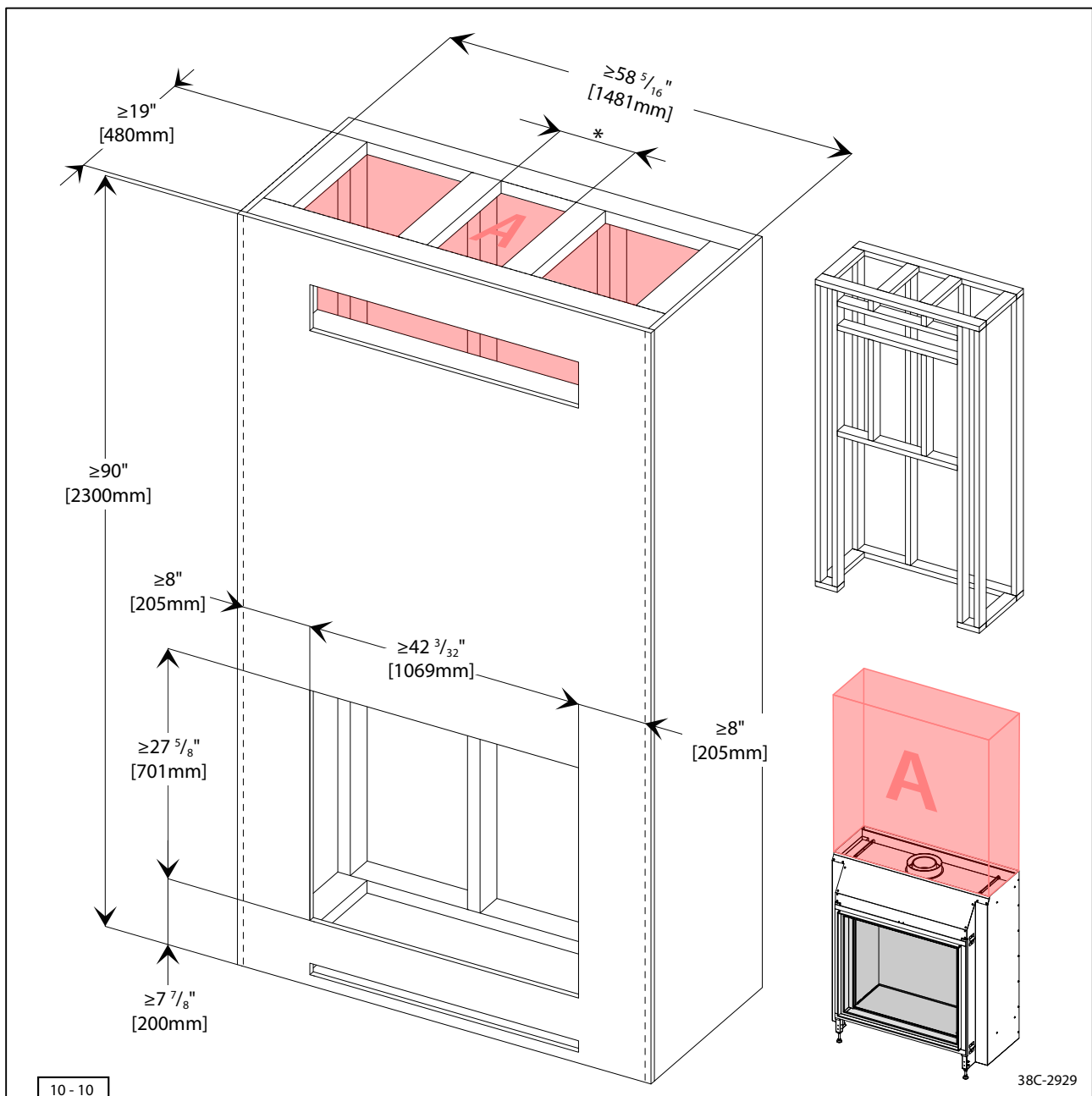

* Size in accordance with the flue manufacturer's specifications.

10.5.5 Heat release and air intake

For appropriate ventilation, provisions for heat release and air intake must be made in accordance with Fig. 10-11.

ⓘ CAUTION

- Heat release and air intake openings must not be covered or blocked.
- The heat release and air intake pictured in Figure 10-11 are a minimum net surface area. Any surface area loss due to finishing materials like a grill or louvre must be compensated for by sizing up.
- Horizontal heat release above the appliance must be constructed to allow for the discharge of hot air into the room.
 - The heat release area must be at least 172 sq. in. [1110 cm²].
 - The heat release must take place in accordance with the dimensions given in Figure 10-11.
 - No obstruction between the heat release and the appliance is permitted (see Fig. 10-10, A).
 - The heat release must not be vented outdoors or to a nonconditioned space.
- The appliance requires a horizontal air intake under the appliance to allow for cool air to enter the chase.
 - The total air intake area must be at least 45 sq. in. [290 cm²].
 - The air intake must be placed in accordance with the dimensions given in Figure 10-11.
 - No obstruction between the air intake and the appliance is permitted.

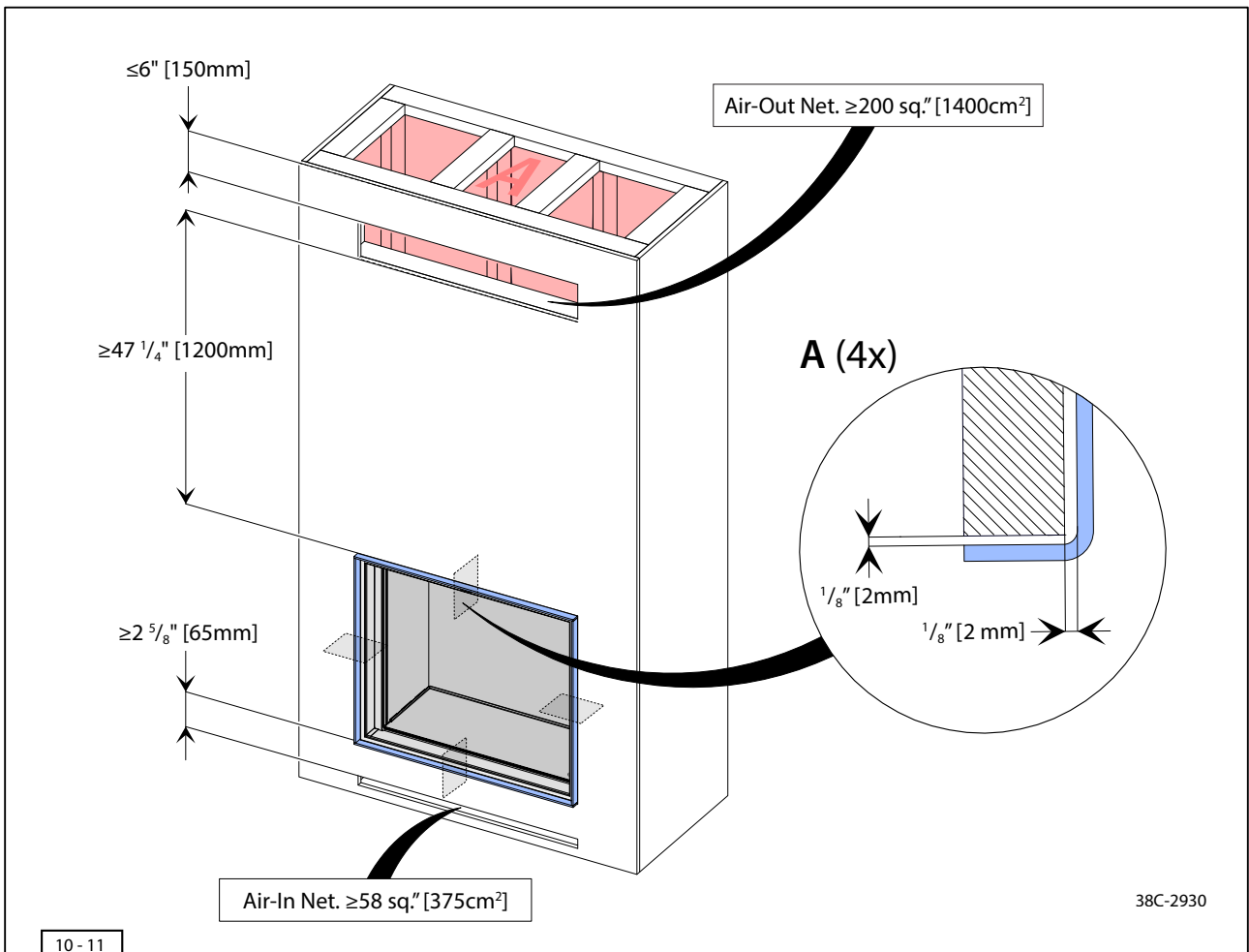

10.5.6 TV recess

A TV set may be installed above the appliance but **ONLY** when recessed into the chase. Follow the dimensions and make sure to never extend the depth of the recess beyond the vertical lip on the top front of the appliance as the space above the appliance must remain clear at all times (see Fig. 10-12).



WARNING

- The recess must be constructed a minimum of 12" [305mm] above the construction frame (see Fig. 10-12).
- The construction and framing of the recess may not exceed 5" [125mm] from the front of the appliance.
- Allow for enough air to flow past the sides of the recess to avoid heat build-up within the chase (see Fig. 10-12).
- To reduce the amount of heat around and under the television, increase the size of the heat release outlet as much as the installation will allow. **ALWAYS** follow minimum heat release requirements.
- Wires inside the chase are not permitted to cross over the appliance. Wires must be installed against the sides of the chase.
- Electric wiring used for the television must be insulated against heat when installed inside the chase above the appliance.
- The wall temperatures within the recess can reach up to 133°F [56°C]; take these temperatures into account when designing the installation of the recess. The temperatures can be reduced by allowing for more heat release and airflow inside the chase.
- Refer to the television's manual for instructions and guidelines for installation above or near a appliance and/or heat source. Installing a television above the appliance is based on the owner's decision and responsibility. DRU cannot be held liable for any adverse effects on a TV, artwork or other equipment located near the appliance. It is the customer's or contractor's responsibility to verify that their TV or artwork can withstand the wall temperatures inside the recess.

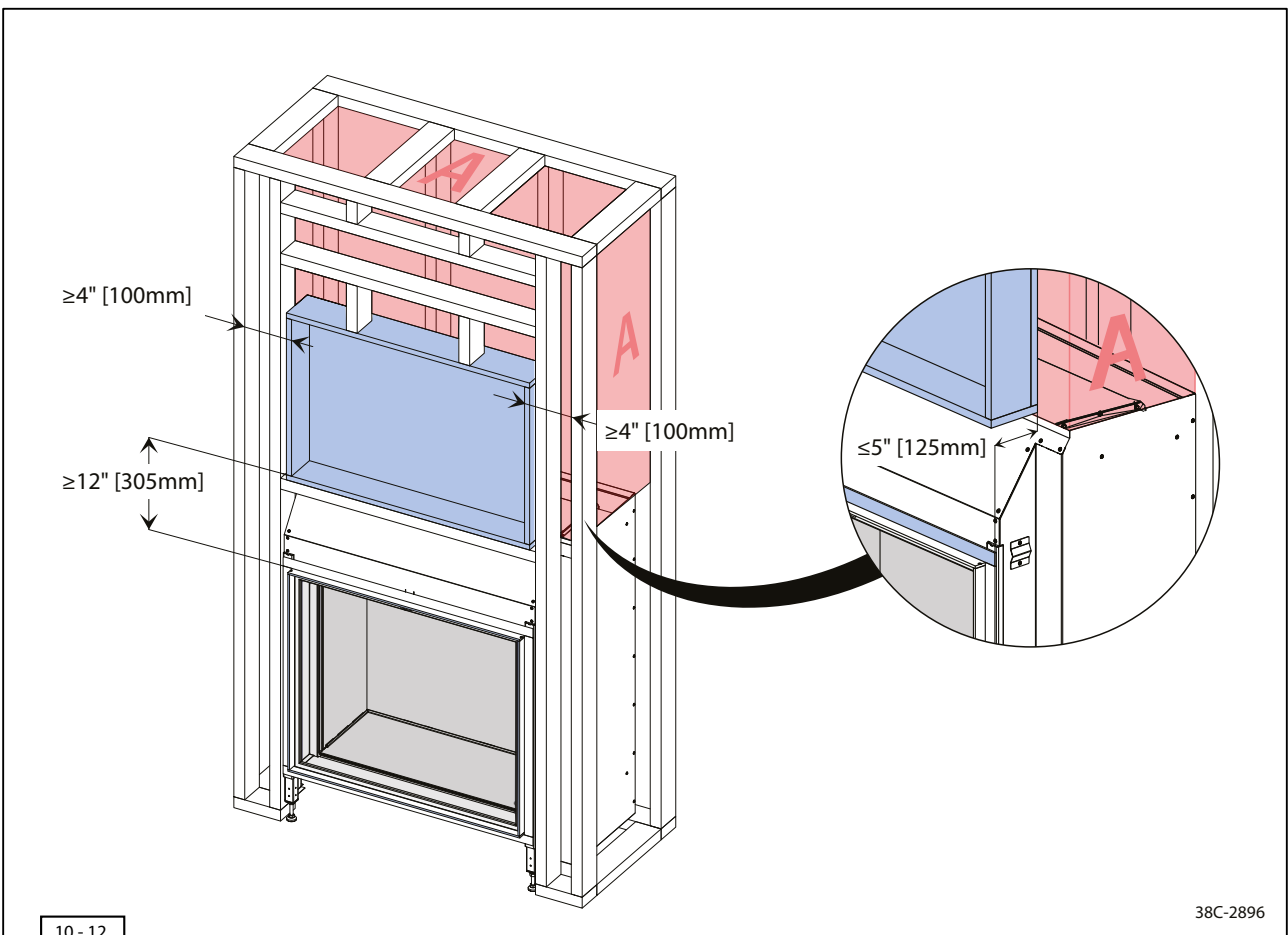

11. Adjusting and setting up the appliance

11.1 Micro Mesh Screen

The Micro Mesh Screen is essential for the safety of the appliance because it is possible that a hot glass pane is touched while in use. The Micro Mesh Screen must always be installed when the appliance is being used.



WARNING

Only perform work on the appliance if it is switched off and at room temperature.



NOTICE

Remove parts such as the Micro Mesh Screen, the Appliance Control Cover, and the door carefully from the appliance to prevent damage.

11.1.1 Removing the Micro Mesh Screen

- Grab the handle at the top of the Micro Mesh Screen and tilt the top forwards so that it is clear of the appliance (Step 1).
- Lift the Micro Mesh Screen out of the bottom frame (Step 2).

11.1.2 Replacing the Micro Mesh Screen

- Push the Appliance Control Cover forward as far as possible (Step 3).
- Position the two positioning brackets of the Micro Mesh Screen in the top corners of the Appliance Control Cover (Step 4).
- Grab the handle at the top of the Micro Mesh Screen and tilt the top backward so that the magnets make contact with the inner frame (Step 5).

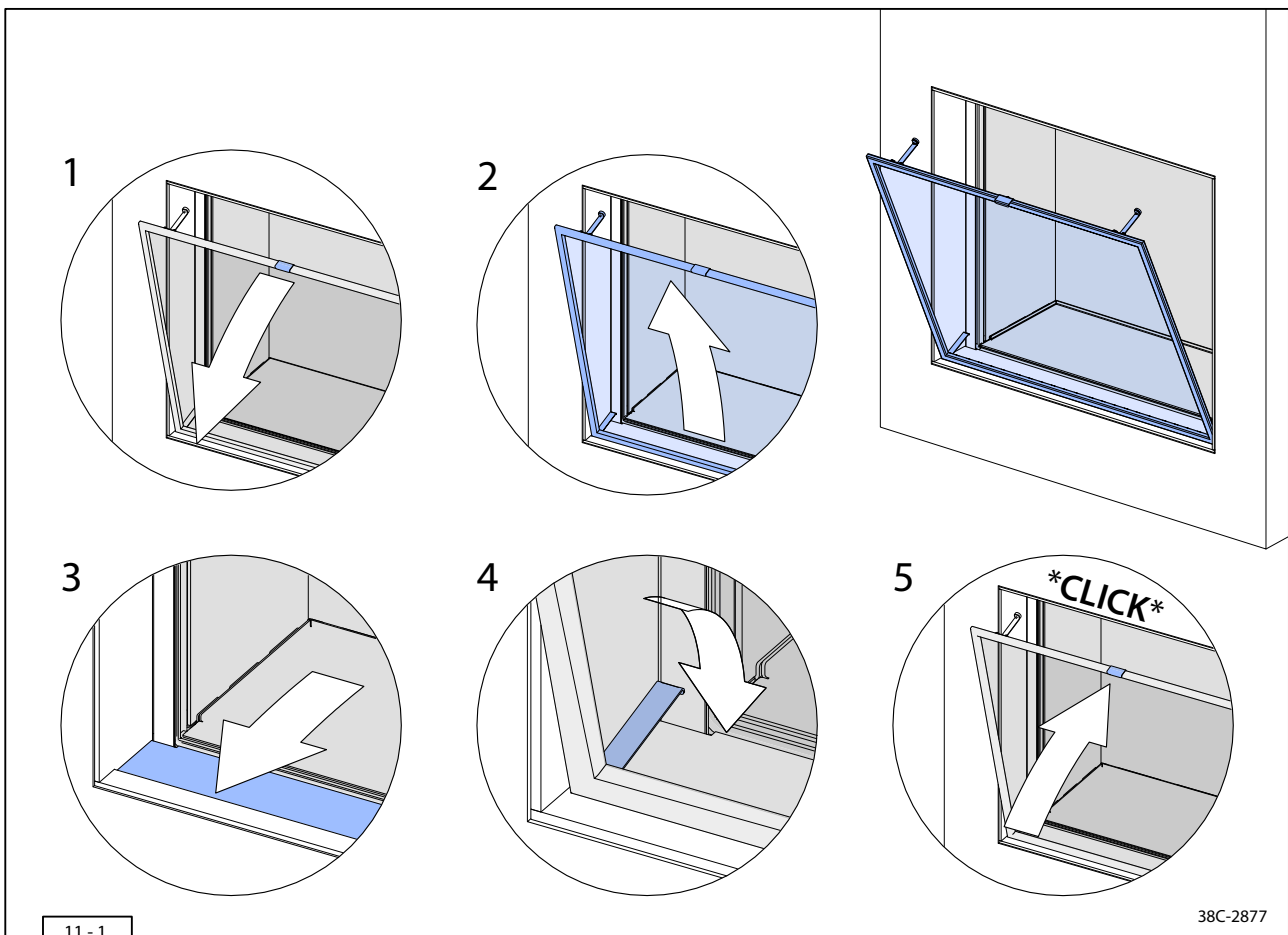

11.2 Appliance Control Cover

The appliance control cover not only enhances the device's appearance but also acts as a safety barrier, concealing its components from the end-user. Follow the instructions below:

11.2.1 Removing the Appliance Control Cover

When removing the Appliance Control Cover, proceed as follows (Fig. 11-2).

- Lift the Micro Mesh Screen out of the appliance (see Section 11.1).
- Carefully push the top of the control cover down so that it tips over forward in the stop (Step 1).
- While it is in the stop, tilt the top of the control cover several inches toward you (Step 2).
- Lift the Appliance Control Cover out of the appliance.

11.2.2 Installing the Appliance Control Cover

When installing the Appliance Control Cover, proceed as follows (Fig. 11-2).

- Replace the Appliance Control Cover by following the steps for removing it in reverse order.

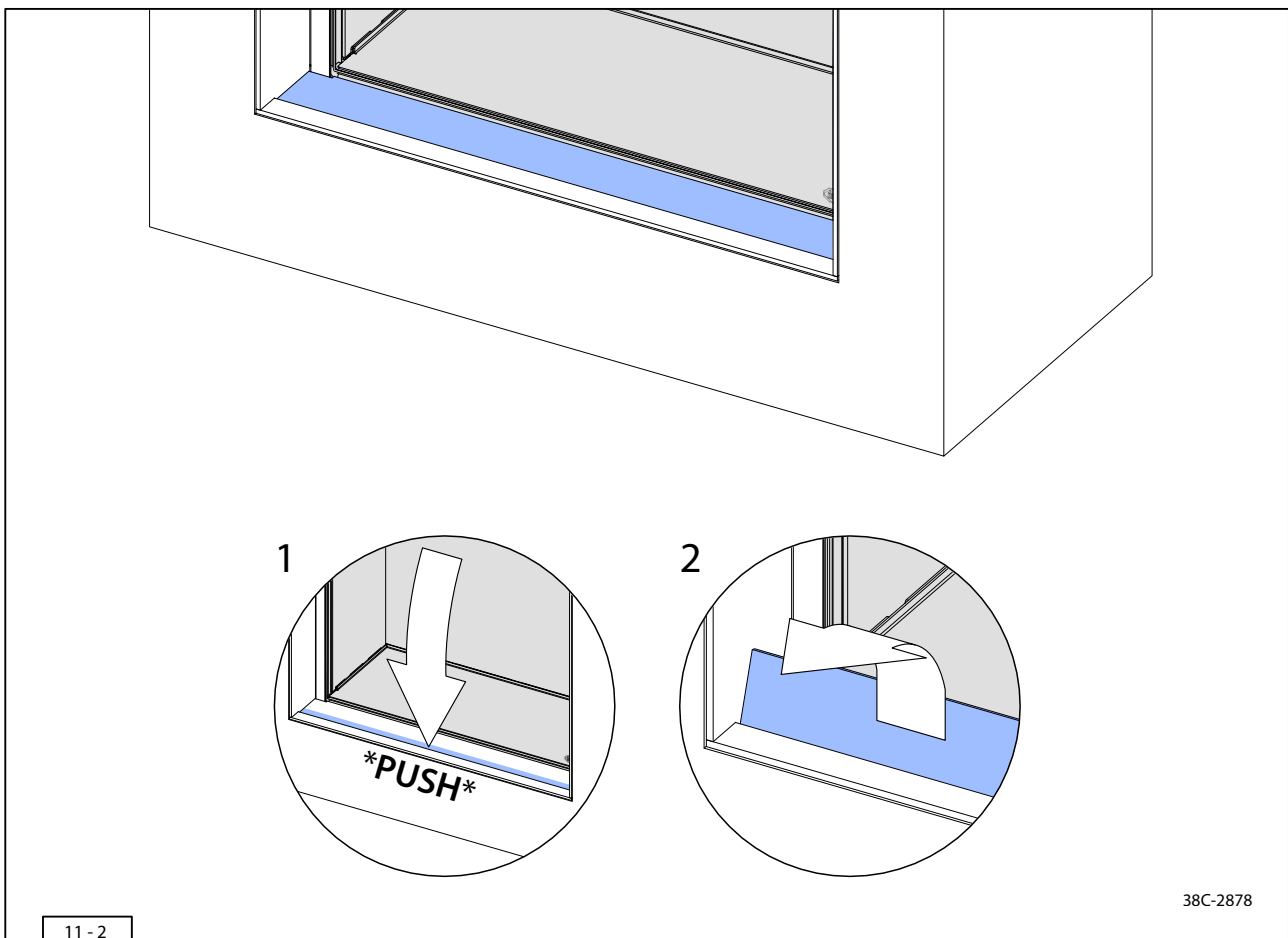

11.3 Door system

The door of this appliance is easy to open to allow maintenance or cleaning of the glass pane on the inside. To position the logs, adjust the appliance, and for maintenance, the door must always be removed. The glass pane must only be removed from its frame if it is cracked or broken. From now on the combination of the door frame and the glass pane are referred to as 'the door'.



WARNING

- Always remove the door when cleaning and performing maintenance work.
- Only remove the door if the appliance is switched off and at room temperature.



CAUTION

- The door system and the stop into which it rests when opened have been developed in accordance with high-quality standards. However, the door system and door are not able to absorb a falling door without causing damage to the appliance. Always make sure that the door is supported while being opened.
- When opening the door, maintain pressure on the top of the door frame. This prevents the door from falling out of the appliance in an uncontrolled fashion. Never leave the appliance unattended with an open door.
- Always treat the door with care to prevent striking and/or slamming shut.



NOTICE

It is important to clean the glass pane with a suitable cleaning product to remove (skin) oils and other contaminants. If this is not done, they can be burned into the glass pane permanently.

11.3.1 Opening and removing the door

Proceed as follows to open the door (see Fig. 11-3).

- Remove the Micro Mesh Screen (see Section 11.1)
- Remove the Appliance Control Cover (see Section 11.3).
- Loosen the bolt of the retaining bracket 3 turns (Step 1).
- Turn the retaining bracket a quarter of a turn to the left to unlock the handle (Step 1).
- ⚠ During step 3, gently pull the door handle away from the glass in order to prevent possible damage to the pane.
- Unlock the door by turning the handle 180° counterclockwise until it clicks into place on the magnet (Step 3).
- Using the two handles at the top left and right of the frame, carefully tilt the door forward out of the appliance until it rests (at an angle of 45°) in the stop (Step 4, top left handle shown).
- ⚠ By removing the door from the appliance with two people, the possibility of damage to the appliance and door is reduced considerably.
- Grasp the door firmly in the center of both sides, tilt the top slightly back toward the appliance and remove it (Step 5).

11.3.2 Replacing the door

To replace the door, follow the Steps as described in Section 11.3.1 in reverse order (see Fig. 11-3).

11.3.3 Replacing glass pane

Follow the steps below to replace the glass pane:



WARNING

- Only a certified installer is authorized to remove the glass using an 8-inch glass-handling suction cup.
- Be careful and wear appropriate safety equipment when handling (broken/damaged) glass.
- The glass pane shall only be replaced as a complete unit as supplied by DRU.

- Remove the door from the appliance as outlined in section 11.2.1.
- Remove the two strips on the left and right of the pane by unscrewing the socket head cap screws.
- Remove the glass pane from the door frame.
- Secure the new gasket to the new pane replicating the placement of the damaged pane.
- Place and center the new pane in the door frame making sure edge clearances are maintained and the gasket on the pane seals completely.
- Place and secure the two strips with the socket head cap screws while making sure to not over-torque.
- Place the door back in the appliance as outlined in section 11.2.2

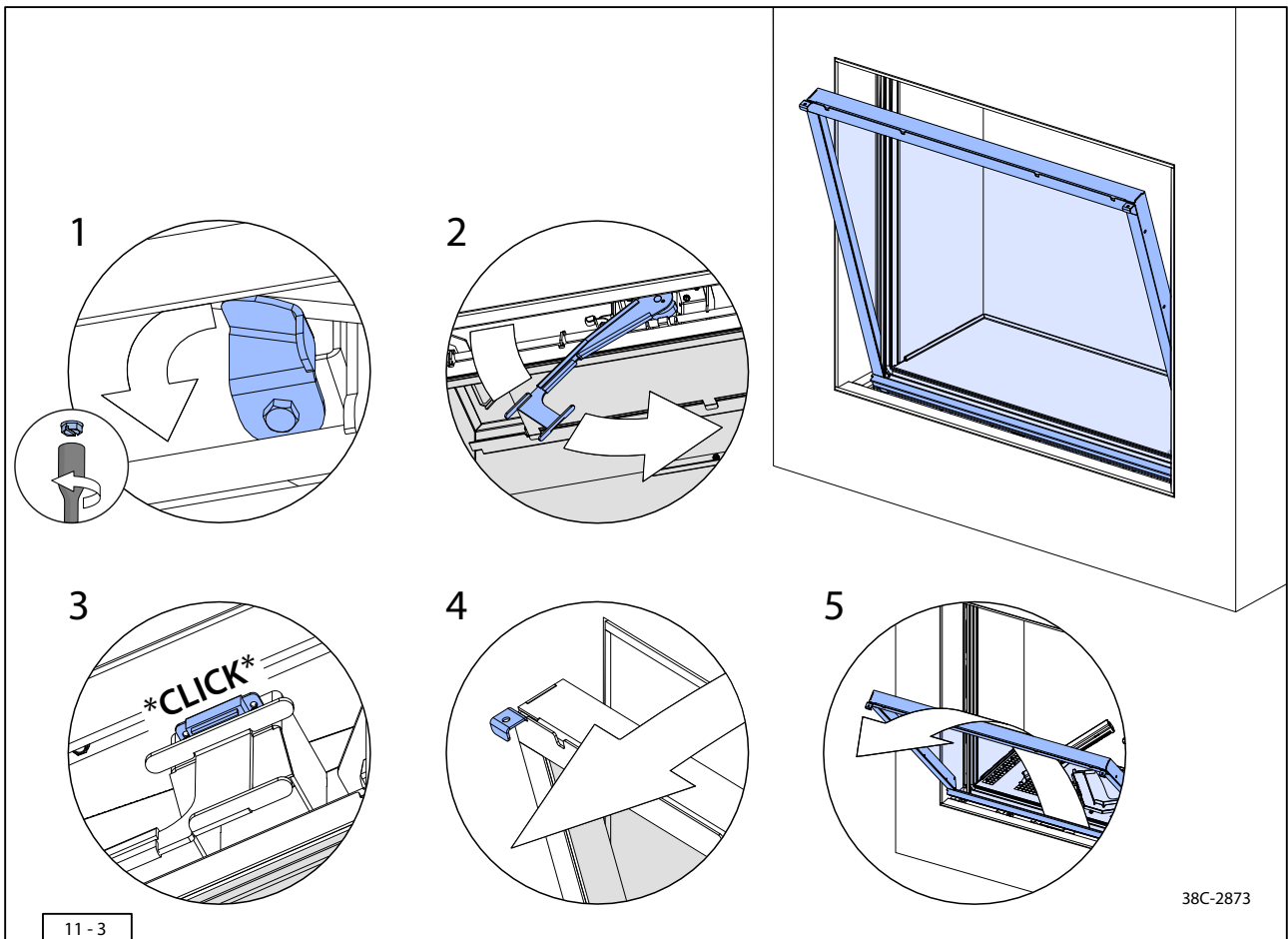

11.4 Adjusting the appliance

The appliance must be set up in such a way that it works correctly in combination with the vent system. It is possible that the vent configuration needs to have a restrictor slide and/or the air inlet guide installed or removed. The conditions for using a wall terminal and roof terminal can be found in Chapter 10.

11.4.1 Adjusting the restrictor slide

The restrictor slide is not installed by default. Install the restrictor slide if the vent configuration prescribes this.

Follow the Steps below for installing and adjusting the restrictor slide (Fig. 11-4):

- Remove the Micro Mesh Screen (Section 11.1), the Appliance Control Cover (Section 11.2) and the door (Section 11.3).
- Unscrew the 3 self-tapping screws with which the flue gas distribution plate is installed in the appliance. Support the plate while unscrewing it (Step 1).
- Carefully tilt the flue gas distribution plate forward and down and remove it straight out of the appliance (Step 2).
- Unscrew the pre-installed self-tapping screws from the appliance. Install the restrictor slide in the appliance using these two self-tapping screws. Do not tighten the self-tapping screws completely so that the restrictor slide can still be adjusted (Step 3).
- Adjust the position of the restrictor slide following the tables in Chapter 10. Make sure the tip of the triangle is in line with the center of the self-tapping screw when in the correct position (Step 4).
- Tighten the self-tapping screws of the restrictor slide (Step 4).
- Replace the flue gas distribution plate in the appliance by positioning it in the strip with the back side first and then tilting the front of the plate up against the stop (Step 5).
- Fasten the flue gas distribution plate with the 3 self-tapping screws (Step 5).

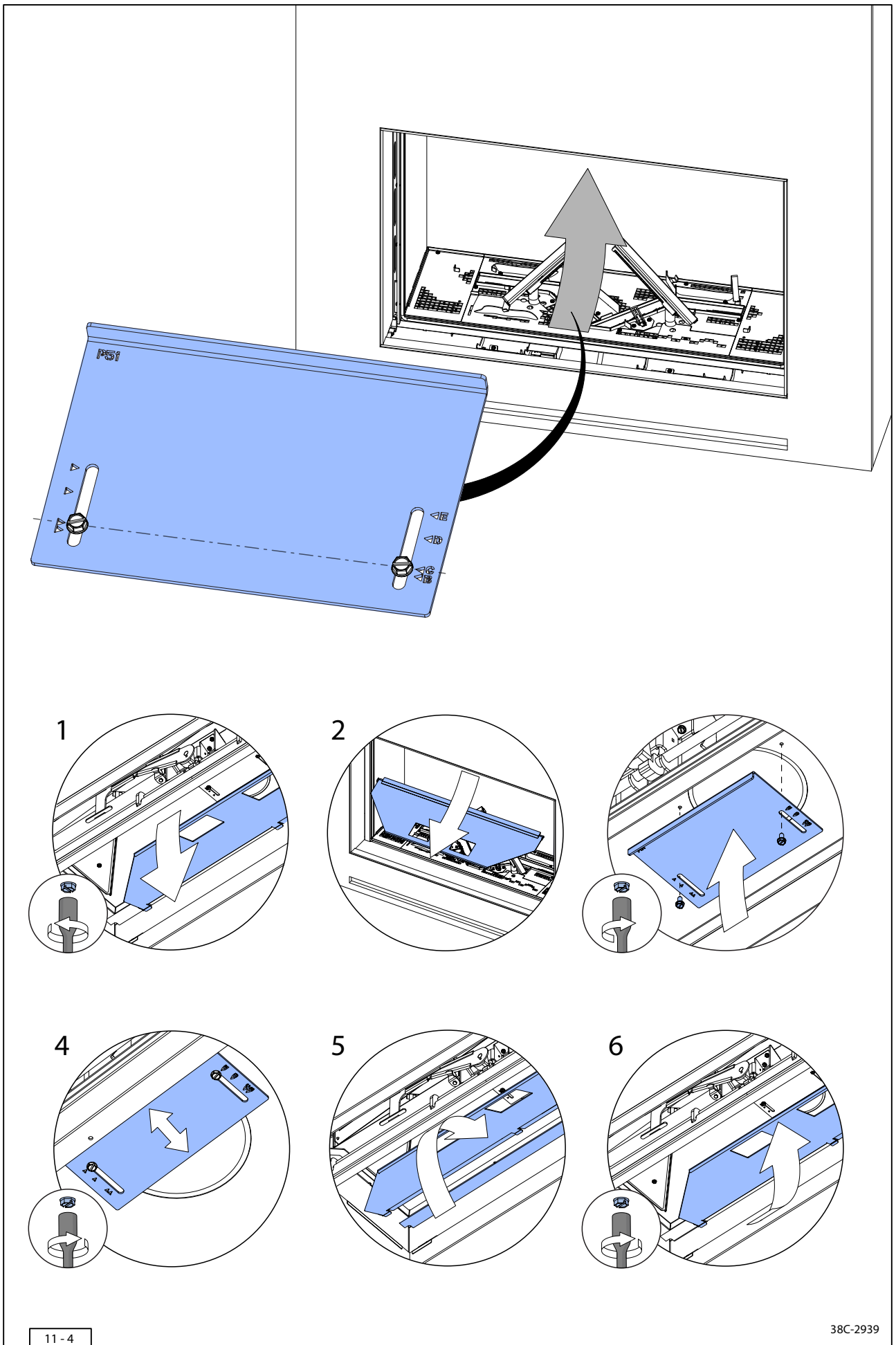

11.4.2 Removing the air inlet guides

The air inlet guides are located to the left and right underneath the bottom plates. Remove or replace them if the selected vent configuration prescribes this (see Chapter 10). Follow the Steps below to remove the air inlet guides (see Fig. 11-5):

- 💡 The low air inlet guides ($\frac{7}{16}$ " [11mm]) are factory-installed upon delivery. The high inlet guides ($\frac{3}{4}$ " [20mm]) are supplied separately in the 'accessories box' (see table 7-1).
- Remove the Micro Mesh Screen (Section 11.1), the Appliance Control Cover (Section 11.2) and the door (Section 11.3).
- Remove the left bottom plate by removing the two self-tapping screws (Step 1).
- Remove the right bottom plate by removing the two self-tapping screws (Step 2).
- Depending on the chosen configuration:
 - Remove both air inlet guides and fasten the self-tapping screws back into the appliance.
 - Replace the low air inlet guides with the high variant ($\frac{3}{4}$ " [20mm]). Fasten with the self-tapping screws (Step 3).
- Replace the left and right bottom plates and fasten back into the appliance with the self-tapping screws (Steps 4 to 1).

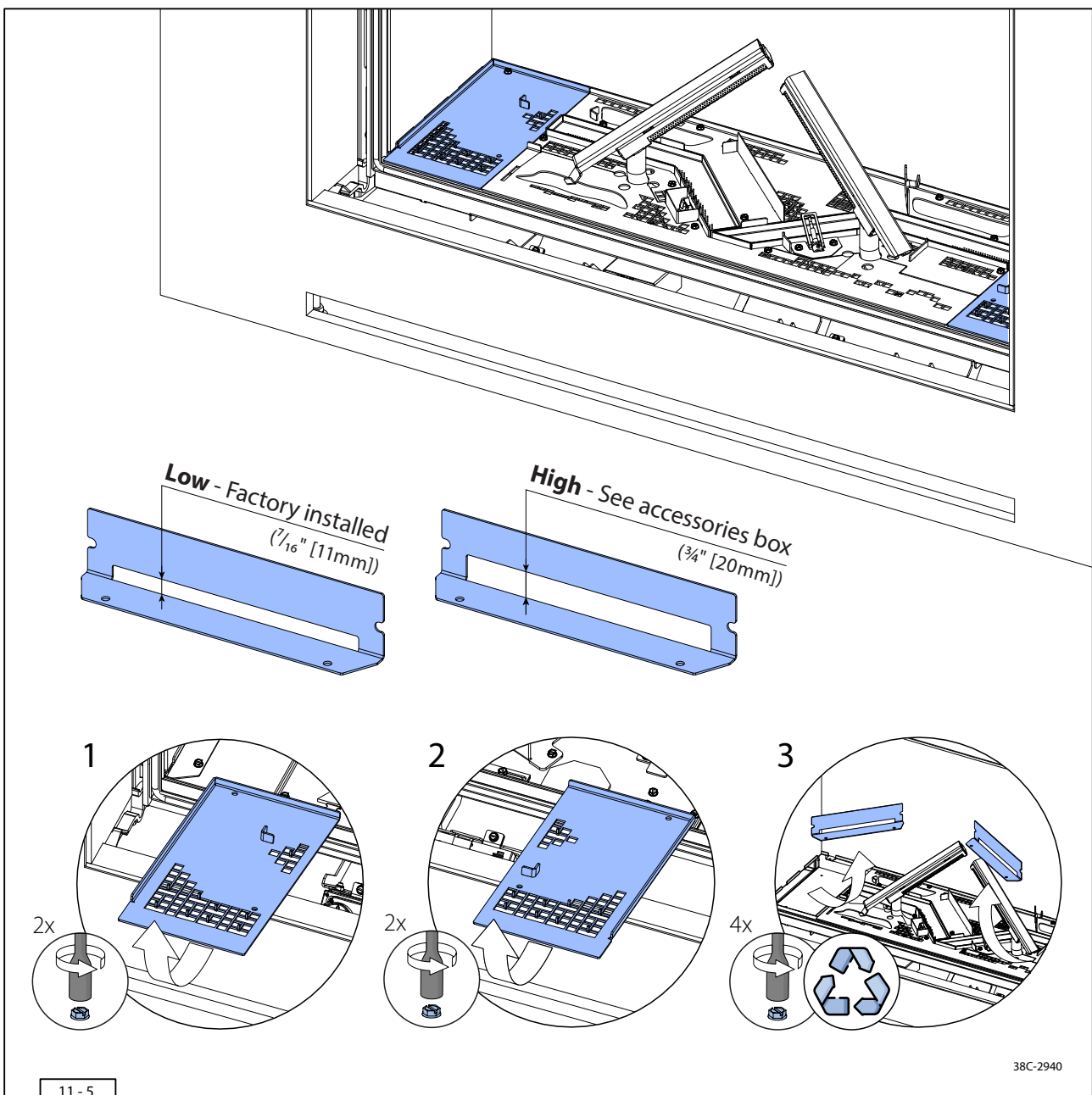

11 - 5

11.5 Setting up the appliance

The appliance comes with a log set that needs to be placed in the appliance. Position the contents of the log set following the directions for a result that looks and feels as natural as possible.



WARNING

- Improper positioning of the logs will cause the main burner to not ignite correctly; this could lead to unsafe situations, unnecessary contamination due to soot and an affected flame pattern.
- Only use the accompanying logs and position them exactly as described.
- The space surrounding the pilot burner, 1st thermocouple, 2nd thermocouple and ignition pins must remain free as shown in this chapter.
 - The 1st thermocouple is located next to the pilot burner. The 2nd thermocouple is located on the right side of the main burner.
 - The 2nd thermocouple will intervene if no appropriate transfer has taken place from the pilot burner to the main burner or from the main burner itself. The gas supply will be interrupted after 22 seconds. In order to solve a poor or non-existent transfer from the pilot burner to the main burner, use the malfunction diagram.
- This appliance is intended for use only with the included DRU burners and accessories. Never install or add any additional or alternative media, rock wool, or other material in this appliance. The use of additional or alternative materials may pose potential safety hazards, damage to the appliance, and void the warranty.



NOTICE

There may be a difference in color between the pictures and the products delivered.



Remove the log set from its packaging and sort out its contents (see Fig 11-6 and 11-7):

- Logs (A to K)
- Glowing embers, orange (L)
- Forge embers, black and gray (M)
- Chips, black and gray (N)
- Vermiculite (O)
- Ash (P)



L

Glowing embers



M

Forge embers



N

Chips



O

Vermiculite



P

Ash



A

P2000 KL10

B

P2002 KL09

C

P2021 KL02

D

P1002 KL04

E

P2008 KL04

F

P1101 KL04



G

P2001 KL02

H

P2005 KL09

I

P2009 KL04

J

P2022 KL08

K

P1089 KL04

11.5.1 Positioning the log set's accessoires

Follow the Steps below for the placing and positioning of the log set's accessoires



CAUTION

- The vermiculite must always cover the entire burner surface but may not extend above the edge of the burner.
- The burner plates have a series of square holes for the air supply to the burners. Position a maximum of one layer of chips over these holes.



NOTICE

When spreading the ash, prevent it from getting on the burners. It will burn into the burners with use.



Fill the main burner with vermiculite until just under the edge (see Fig. 11-8, 11-9, 11-10).



The flame pattern and flame height can be affected by the positioning of the vermiculite. Redistributing the vermiculite may result in a better flame pattern.



For the following steps, switch on the appliance and turn on the Eco Glow lighting. Position the forge and the glowing embers in such a way that the effect is most realistic.



The uneven shape of the glowing embers may cause scattered light in- and outside of the appliance. Strategic placement of the embers and forge embers can prevent this effect almost completely.



Distribute the glowing embers over the glass plates in the base plates. After covering them completely, the other embers can be used to overflow onto the rest of the base plates. Keep the areas marked in red free of any glowing embers (see Fig. 11-11 and 11-12).



Fill the base plates evenly with the chips in a natural-looking manner. Keep the areas marked with red free of chips (see Fig. 11-11 and 11-12).



Distribute the forge embers over both the chips and the glowing embers in a random and natural-looking manner while keeping the areas marked with red free of forge embers (see Fig. 11-11 and 11-13).



The space at the front of the base plates must be kept free of materials (see Fig. 11-11). Move if necessary.



(Optional) Distribute the ash in a natural-looking manner over the chips and embers. Prevent ash from getting on the burners.

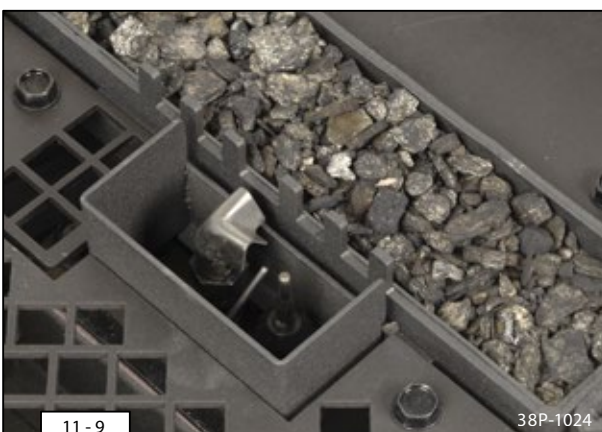

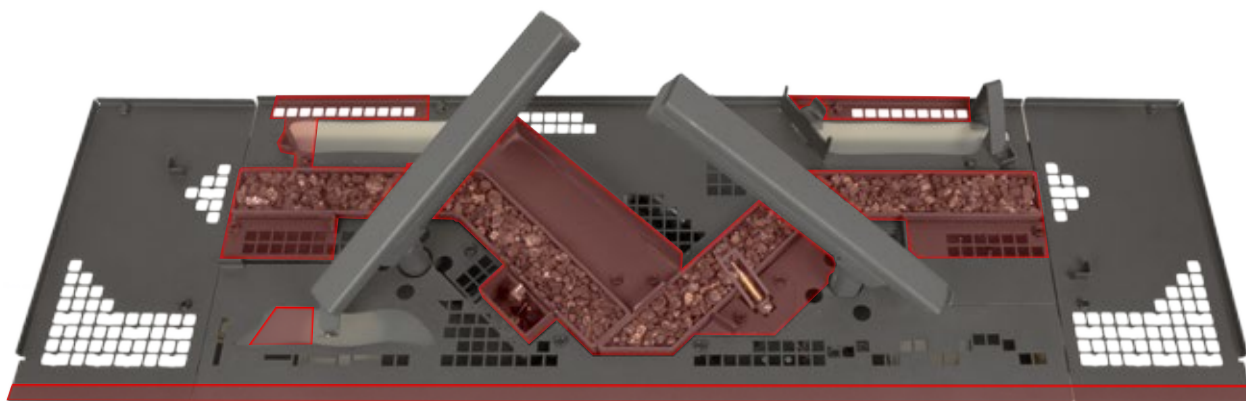

11 - 11

38P-1018



11 - 12

38P-1020



11 - 13

38P-1021



11 - 14

38P-1022

11.5.2 Positioning the logs

Follow the steps below for positioning the logs in the appliance. Use the overview pictures (Figs. 11-14, 11-15/23, 11-16 and 11-24) in combination with the detail pictures (Figs. 11-17/11-22 and 11-25/11-29) to position the logs. Use the shape, color and stains on the logs while sorting and positioning.



WARNING

After positioning, make sure that the space above the pilot flame and the spark electrode remain partially free (see Figs. 11-9 & 11-10).

- Sort the logs as shown in Figure 11-7.
- Place log A on the main burner in the positioning brackets (see Figs. 11-16 & 11-17).
- Place log B on the positioning bracket to the left and on log A to the right (see Figs. 11-16 & 11-18).
- Place log C over the left burner (see Figs. 11-16 & 11-19).
- Place log D against the positioning bracket to the left and on log C to the right. Make sure the edge of log D has "X"[Xcm] with the front of log C (see Figs. 11-16 & 11-20).
- Place log E against the positioning bracket (see Fig. 11-16 & 11-21).
- Place log F on the edge of the ignition module, parallel to the main burner (see Fig. 11-16 & 11-22). Leave enough open space above the pilot burner for it to function properly.

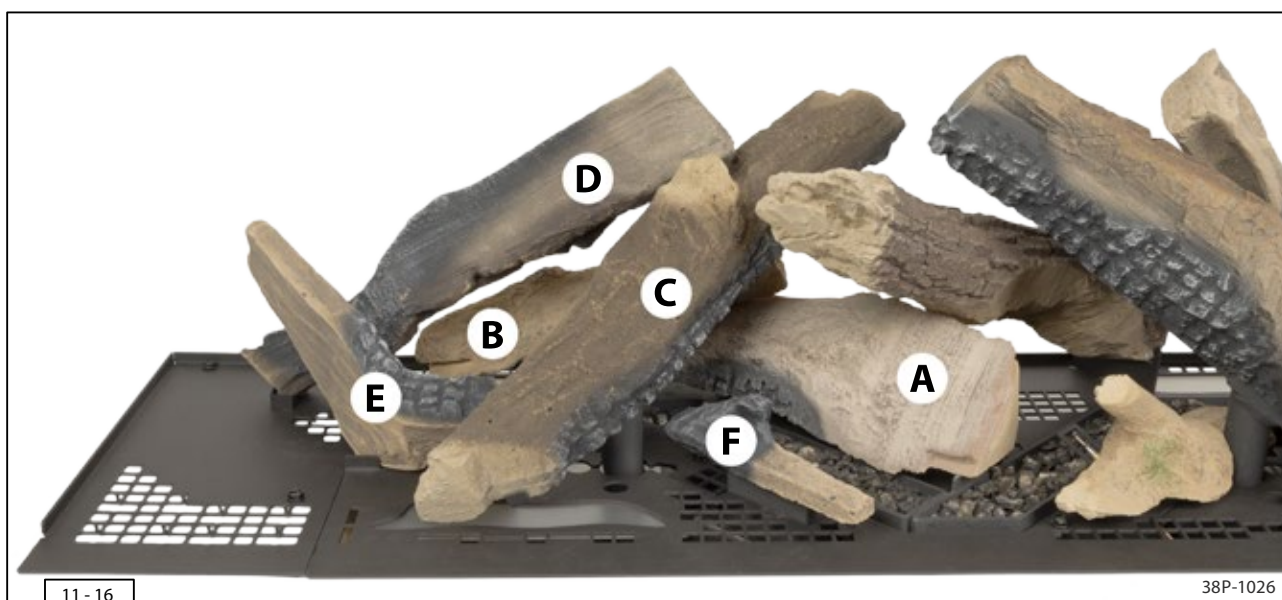

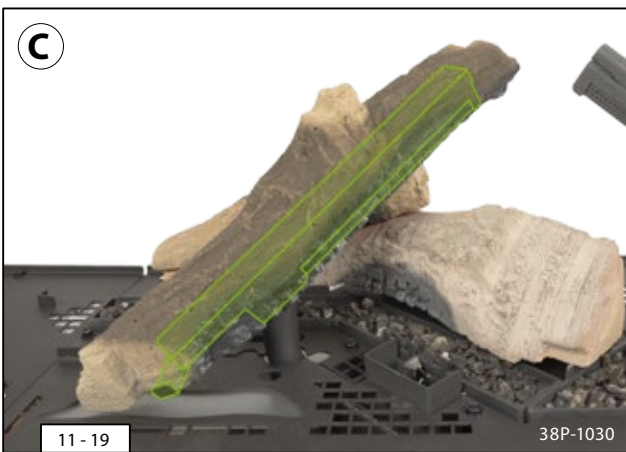
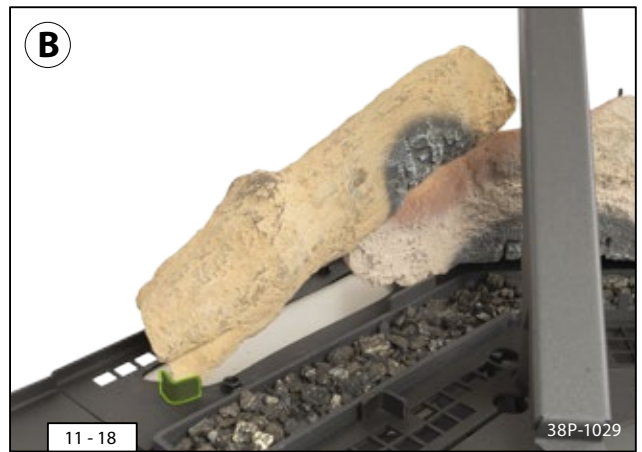
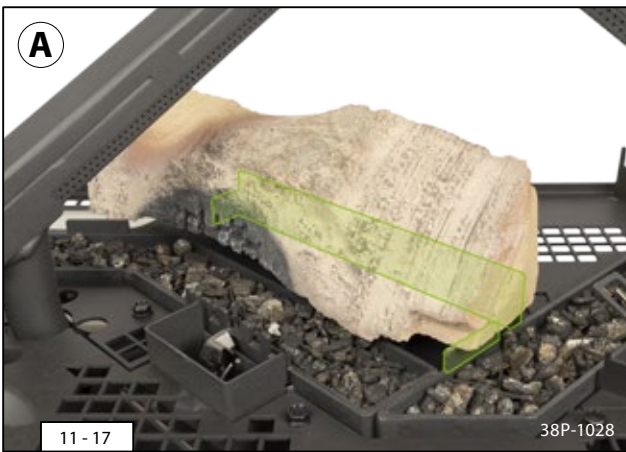

- Place log G on the positioning bracket and on top of log B. Position the front-facing side of the log about 1" [25mm] away from the face of log B (see Figs. 11-24 & 11-25).
- Place log H in the positioning bracket and up against the tube of the right burner (see Figs. 11-24 & 11-26).
- Place log I on the positioning bracket to the left and against the positioning bracket on the right (see Figs. 11-24 & 11-27).
- Place log J over the right burner (see Figs. 11-24 & 11-28).
- Place log K against the positioning bracket to the right and on log J to the left. Make sure the edge of log K has 4" [100mm] with the front of log J (see Fig. 11-24 & 11-29).

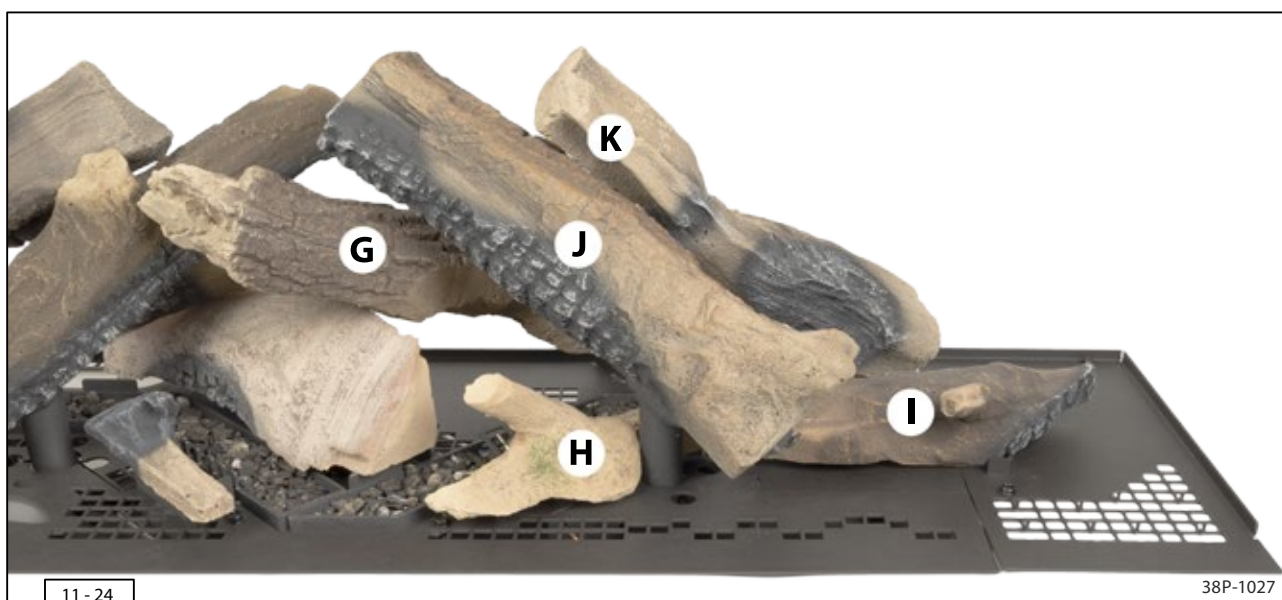

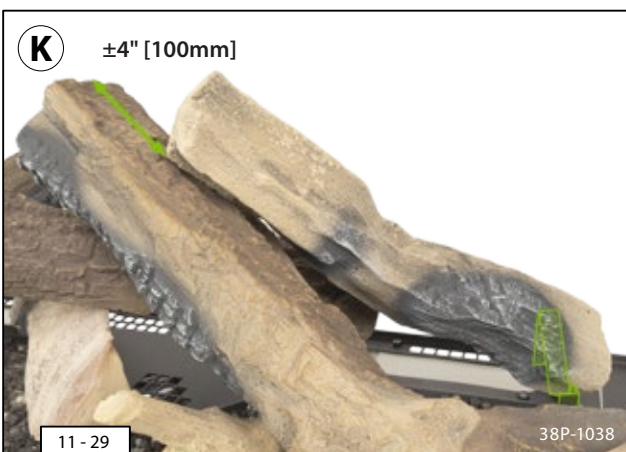
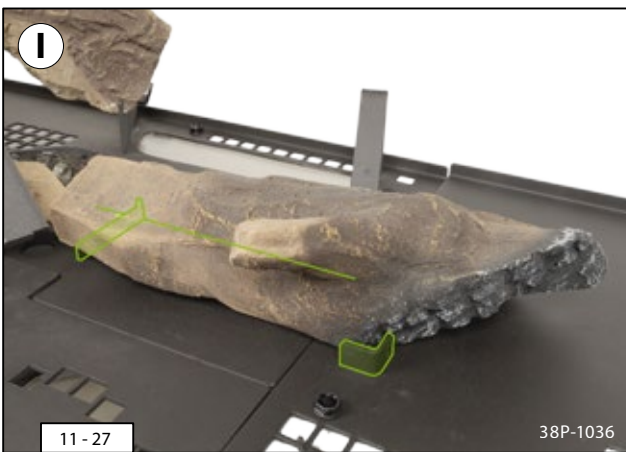
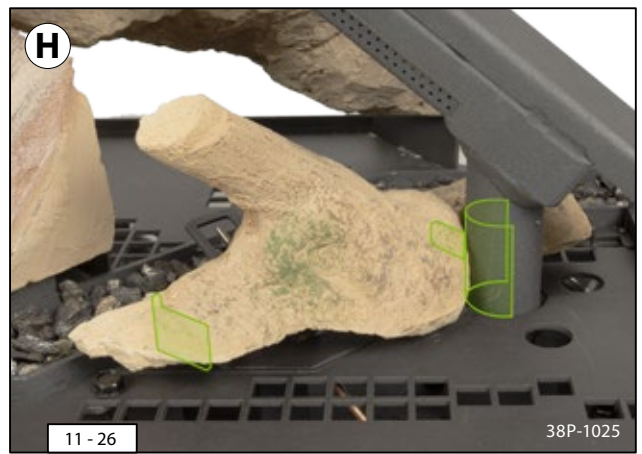
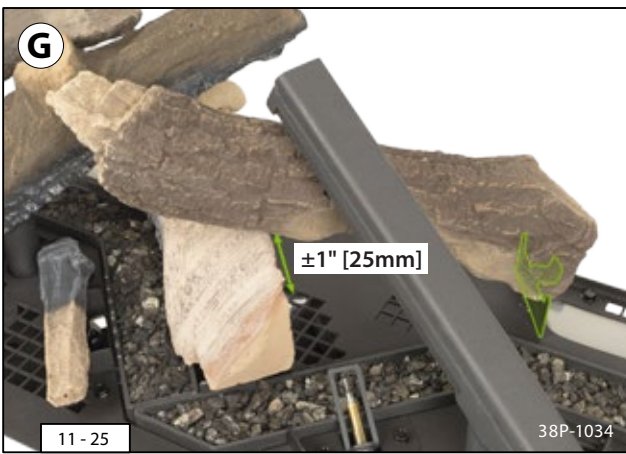

12. Final check

For a good and safe operation of the appliance, the following checks and adjustments must be performed prior to putting into operation.



DANGER

- Pets and birds in particular are sensitive to the vapors that are released when heating for the first time.
Remove the animals and keep the room well ventilated.
- When igniting without a glass pane after installation or maintenance work, at least the following conditions must be met in addition to national and local regulations:
- Always check the pressure relief system as described in section 7.4 before lighting the appliance.
- It is possible that, when igniting for the first time, a flame may burst out of the appliance. Be sure to have taken **AT LEAST** the following safety measures:
 - Remove combustible materials around and in front of the appliance, and keep a fire extinguisher within reach.
 - Remove children, animals (especially birds) and other people from the room.
 - Make sure the room is properly ventilated.
 - Keep sufficient distance from the appliance and ignite using the remote control.



WARNING

- During the ignition process, the gas control may **NOT** be operated manually.
- Wait at least 5 minutes after extinguishing the pilot flame before trying to ignite it again.
- The pilot flame may not be set lower using the adjustment options on the gas control.
- The pilot burner should ignite the main burner within a couple of seconds.
- The main burner(s) must transfer the flame to the entire burner smoothly without popping and must continue to burn.
- All connections must be gastight. Check all connections for gastightness. The gas control can be subjected to a maximum pressure: 10.5 W.C." [2,61kPa].
- After installation, or after work has been performed, ignite the appliance for the first time without the door installed. If necessary, bleed the gas line.
- The supply pressure in domestic systems must be checked prior to ignition.



NOTICE

- When checking the main burner without the door, it may shut itself off after 22 seconds. This is a safety mechanism that is caused by the second thermocouple. If this happens, it may be regarded as a successful test result.
- When the gas valve is opened, the motor will start to run; this is audible. The flame pattern and a good flame transfer can only be properly assessed if the glass pane has been installed. Consult the troubleshooting diagram in the Chapter 15 if ignition of the main burner does not comply with the aforementioned requirements.
- The flame pattern and a good flame transfer can only be assessed when the door is installed and/or closed.

12.1 Gas pressure/supply pressure

The supply pressure needs to be checked. Follow the steps below (see Fig. 9-3):

- Confirm the main gas supply line is closed.
- Remove the Micro Mesh Screen, the Appliance Control Cover and the door from the appliance.
- Open the valve of the supply pressure measuring nipple a few turns with a flat-head screwdriver and connect the pressure gauge (see Fig. 9-3, (1)).
- Open the main gas supply and check the static supply pressure (see Table 8-1 of the installation manual).
- ⚠ If there is deviation: check the pressure at the gas meter. Contact the gas company if the supply pressure is too high or too low at the gas meter.
- Close the main gas supply.
- Disconnect the pressure gauge and close the valve of the supply pressure measuring nipple (see Fig. 9-3, (1)).

12.2 Ignition for the first time

- Open the main gas supply and start the ignition procedure as described in Chapter "Ignition" of the user manual.
- If the pilot flame does not ignite:
 - Repeat the ignition procedure until the pilot burner ignites;
 - Consult the fault codes table in the installation manual if this does not happen after a few attempts.
- After igniting the pilot flame, the main burner will ignite and will automatically set to the highest setting.

12.3 Final check

- 💡 The flame pattern and a good flame transfer can only be assessed when the door is installed and/or closed.
- Clean the glass pane on the inside before first operation as described in the user manual.
- Replace the door, the Appliance Control Cover, and the Micro Mesh Screen in the appliance as described in corresponding chapters of the installation manual.
- Switch the appliance on and open the gas supply.
- Repeat the ignition procedure a few times and perform checks as described in chapter "Final check" of the installation manual.
- Check the operation of the main burner from a cold condition (pilot flame off), it should ignite within a few seconds.
- From now on, the pilot flame must ignite and the burners must burn smoothly.
- Check that the flame pattern is right.
- See chapter "Malfunctions" of the installation manual if the flame pattern is not right.
- Clean the glass pane after heating for the first time as described in the user manual.

12.4 First time using the appliance

When heating for the first time, the flame pattern can be affected by the curing of paints and solvents. In case of a cold start, the appliance must first reach the correct temperature before the flame pattern can be assessed.

13. Delivery

During delivery, familiarize the user with the appliance and its operation. The user manual explains all aspects that are relevant to the user in a step-by-step manner, but will rarely beat a thorough and personal instruction.



WARNING

- Inform the user that, in case of malfunctions/poor operation, to close the gas valve immediately and contact a competent installer to prevent unsafe situations.
- Pets and birds in particular are sensitive to the vapors that are released when heating for the first time.
Remove the animals and keep the room well ventilated.



NOTICE

Wait at least 6 weeks before putting the appliance into operation if the chase is made of stone-like materials and/or has been finished with plaster in order to prevent shrinkage cracks.

- Instruct the user about the appliance and its operation.
- Hand over all documents and manuals to the end-user (all manuals should be stored near the appliance).
- Important aspects for the benefit of the user's safety that the user must be familiarized with:
 - The location of the gas valve and the electric 120V connection
 - Closing the gas valve and disconnecting the appliance from the power supply.
 - The location of the rating plate.
- Inform the user about the following:
 - In order to prevent cracks, a chase made of stone-like materials or finished with plaster must dry at least 6 weeks prior to putting the appliance into operation.
 - Cleaning the glass pane(s).

14. Maintenance

14.1 Maintenance guidelines

DRU strongly recommends the appliance and vent-system are cleaned and inspected once a year by a qualified service technician. Follow the steps and guidelines listed below when performing a maintenance check:



WARNING

- Close the gas shut-off valve and disconnect the appliance from the power supply prior to starting maintenance work.
- Always check the gastightness after carrying out maintenance and/or repairs.
- Always check the pressure relief system as described in section 7.4 before lighting the appliance after maintenance work.
- Verify proper operation after servicing.



CAUTION

- Do not use ammonia or abrasive cleaners on the glass and appliance, as they will permanently etch the surface. Use an approved gas appliance cleaner.
- Label all wires prior to disconnection when servicing controls. Wiring errors can cause improper and dangerous operation.



NOTICE

- Under no circumstances may a stainless steel concentric system be cleaned (internally) with, for example, a steel brush or metal sponge. This will damage the oxide scale as a result of which pit corrosion and/or system leaks could occur.
- Avoid damaging the glass pane and door system.
- Prevent/remove fingerprints on the glass pane as they will burn into the glass.
- Clean the glass pane as described in the user manual.
- Regularly remove any deposits as they can burn into the glass pane.
- Only clean a glass pane when it is at room temperature.
- Never use the appliance with a broken and/or cracked glass pane.

- Clean the glass pane on the inside of the appliance with a suitable cleaning agent.
- Inspect the ignition module and the second thermocouple for correct operation. Replace, repair, and clean them if necessary (Use the diagram in Appendix F as reference).
- Inspect the main burner and upright burners for condition, correct operation and ignition. If necessary, make adjustments and clean (Use the diagram in Appendix F as reference).
- Inspect the combustion vent-system. Clean if necessary.
- Always end a final inspection as described in Chapter 13.

14.2 Components

Replacement parts are available at your dealer or the DRU website. See the Appendix H for the full list of available parts.

15. Malfunctions

When the appliance malfunctions, the following can be used to determine the cause together with the relevant possible solutions.

- 💡 - Table 15-1 lists error codes that the remote control can display together with an explanation and possible cause of the problem.
- The Tables 15-2 list the malfunctions that can be read on an iOS or Android smart device with the help of the DRU Fire App. The use of the Wi-Fi module, which can be purchased separately, is required for this.

Use the interactive fault finder on the DRU Service website by scanning the QR code below. The fault finder can also be accessed directly via drufire.com/en-us/dru-troubleshooter-2

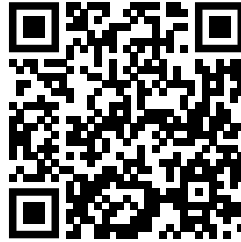

Scan the QR code to visit the interactive fault finder tool at drufire.com



NOTICE

The information in this installation manual always takes precedence over the DRU Service website.

Table 15-1: Remote - Fault codes

Fault code	Symptom	Possible cause
F04 Ignition sequence malfunction, wait 1 minute and retry ignition.	<ul style="list-style-type: none"> • No pilot flame within 30 seconds (After 3 failed ignition sequences, F06 is displayed) 	<ul style="list-style-type: none"> • No gas supply • Air in the pilot supply line • No spark • Reversed polarity in the thermocouple wiring
F06	<ul style="list-style-type: none"> • 3 failed ignition sequences within 5minutes • Fire is not responding; no pilot flame 	<ul style="list-style-type: none"> • No gas supply • Air in the pilot supply line • No spark • Reversed polarity in the thermocouple wiring • Check for correct pilot orifice (LPG to NG or vice versa)
F09	<ul style="list-style-type: none"> • The appliance is not responding • No electronic control of the appliance 	<ul style="list-style-type: none"> • Down arrow button was not pressed during synchronization. • Receiver and handset are not synchronized
F46	<ul style="list-style-type: none"> • The appliance is not responding • Intermittent response • No electronic control of the appliance 	<ul style="list-style-type: none"> • No or bad connection between the receiver and handset • No power at the receiver • Low communication range (electrical grid adapter faulty, handset not communicating with receiver)

Table 15-2: DRU Fire App - Fault codes

Error code	Symptom	Possible cause
F02	<ul style="list-style-type: none"> • 5 second beep from the receiver • The appliance is not responding; no ignition 	<ul style="list-style-type: none"> • Faulty Microswitch • Faulty wiring of the motor • Bent motor knob
F03	<ul style="list-style-type: none"> • 5 second beep from the receiver • Ignition process is interrupted • The appliance is not responding; no ignition 	<ul style="list-style-type: none"> • Thermocouple wiring is incorrect • Thermocouple wiring is not connected
F04 Ignition sequence malfunction, wait 1 minute and retry ignition.	<ul style="list-style-type: none"> • No pilot flame within 30 seconds. After 3 failed ignition sequences, F06 shown 	<ul style="list-style-type: none"> • No gas supply • Air in the pilot supply line • No spark • Reversed polarity in the thermocouple wiring • Check for correct pilot orifice (LPG to NG or vice versa)
F05	<ul style="list-style-type: none"> • Flame failure during ignition • Motor stays in pilot position 	<ul style="list-style-type: none"> • Not enough thermovoltage • Air in the pilot supply line • Low inlet pressure • Bad thermocouple
F06	<ul style="list-style-type: none"> • 3 failed ignition sequences within 5 minutes • Appliance is not responding; no pilot flame 	<ul style="list-style-type: none"> • No gas supply • Air in the pilot supply line • No spark • Reversed polarity in the thermocouple wiring • Check for correct pilot orifice (LPG to NG or vice versa)
F07 Replace the remote control batteries	<ul style="list-style-type: none"> • The battery icon flashes on handset display 	<ul style="list-style-type: none"> • Low battery power in handset
F10	<ul style="list-style-type: none"> • Pilot lit • Main burner fails to ignite and pilot shuts off • Ignition is blocked for 2minutes 	<ul style="list-style-type: none"> • 2nd thermocouple is out of position • 2nd thermocouple wiring is incorrect • Log(s) out of position • Gas ports for burner are blocked • Chips/embers placed too close to ignition and/or 2nd thermocouple
F12	<ul style="list-style-type: none"> • Motor turns to pilot position 	<ul style="list-style-type: none"> • The receiver temperature exceeds 131°F [55°C] • Check appropriate functioning of air circulation and heat shield
F13	<ul style="list-style-type: none"> • Motor turns to pilot position • Fan at level 4 for 10minutes (T >176°F [>80°C]) 	<ul style="list-style-type: none"> • The receiver powered by mains power and the receiver temperature exceeds 176°F [80°C] • Check appropriate functioning of air circulation and heat shield
F14	<ul style="list-style-type: none"> • 5 second beep from the receiver • The appliance is not responding; no ignition 	<ul style="list-style-type: none"> • The receiver software does not support a 2nd thermocouple • Wrong receiver
F15	<ul style="list-style-type: none"> • 5 second beep from the receiver • The appliance is not responding; no ignition 	<ul style="list-style-type: none"> • 2nd thermocouple wiring is incorrect or not connected • Thermocouple is faulty
F16 Handset out of range	<ul style="list-style-type: none"> • No temperature shown in the app 	<ul style="list-style-type: none"> • Handset out of range formore than 1.5 hours • Radio interference

Table 15-2: DRU Fire App - Fault codes

Error code	Symptom	Possible cause
F17	<ul style="list-style-type: none"> The appliance is not responding; no ignition 	<ul style="list-style-type: none"> Inlet voltage exceeds 7.25V
F19	<ul style="list-style-type: none"> Pilot drops when motor opens main gas 	<ul style="list-style-type: none"> Insufficient thermocouple voltage Thermocouple malfunction Low inlet gas pressure Incorrect thermocouple flame trapped Weak pilot flame Carbon build-up on thermocouple Resistance in thermocurrent circuit too high
F21	<ul style="list-style-type: none"> Pilot drops when motor opens main gas 	<ul style="list-style-type: none"> Draft too high Cold junction temperature too high Magnet unit drops
F27	<ul style="list-style-type: none"> Turns to pilot flame position 	<ul style="list-style-type: none"> No handset communication with the receiver for more than 3 hours
F28 On-demand pilot	<ul style="list-style-type: none"> Pilot shuts off after a predefined time 	<ul style="list-style-type: none"> Pilot shuts off after no motor movement for a predetermined time
F31	<ul style="list-style-type: none"> The appliance is not responding No electronic control of the fire 	<ul style="list-style-type: none"> The receiver or Wi-Fi module malfunctions
F41 Check Wi-Fi	<ul style="list-style-type: none"> The fire is not responding No electronic control of the fire 	<ul style="list-style-type: none"> No Wi-Fi connection to the Wi-Fi module, the router and/or the smart device Wi-Fi in smart device is deactivated
F42 Check Wi-Fi	<ul style="list-style-type: none"> The appliance is not responding No electronic control of the fire 	<ul style="list-style-type: none"> No power to the router No Wi-Fi connection to the router and/or smart device Smart device not in the correct home network
F43 No receiver connected	<ul style="list-style-type: none"> The appliance is not responding No electronic control of the fire 	<ul style="list-style-type: none"> No communication between the receiver and Wi-Fi module Connection cable from receiver to Wi-Fi module faulty
F44	<ul style="list-style-type: none"> No temperature shown in the app N/A (not applicable) displayed in the app 	<ul style="list-style-type: none"> Handset not within range Low battery power in handset
F48 Check the electrical grid	<ul style="list-style-type: none"> The appliance is not responding No electronic control of the fire 	<ul style="list-style-type: none"> Low power supply to Wi-Fi module (U <4.8 VDC)

Prestige 51

User manual







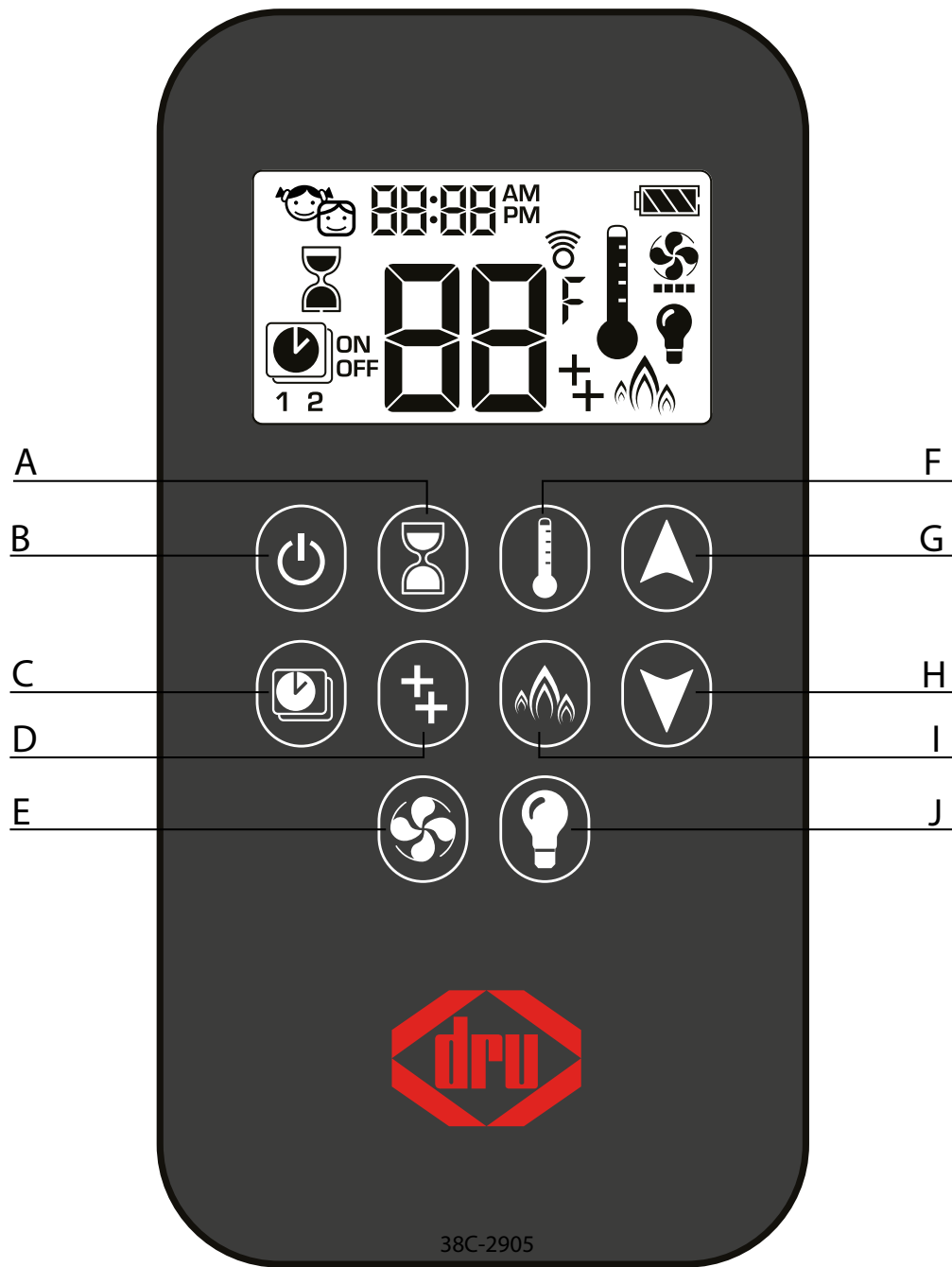















958.022.00



User manual	
1. Safety	74
2. General safety instructions	76
2.1 Front clearance to combustible materials	76
2.2 Putting the appliance into operation	77
2.3 Heating for the first time	77
2.4 Discoloration of walls and ceilings	77
3. Operating the appliance	78
3.1 Drufire App	78
3.2 Home automation	78
3.3 Placing/replacing the batteries 	78
3.4 Remote control pairing	80
4. Remote control	81
4.1 Ignition  + 	81
4.2 Switching off the appliance 	81
4.3 Standby mode (Pilot flame)	82
4.4 Flame height adjustment	82
4.5 Designated low fire and high fire	82
4.6 Switching the second burner on/off	83
4.7 Thermostatic Mode 	83
4.8 Program Mode 	84
4.8.1 Activate/Deactivate Program Mode	84
4.8.2 Program Mode Setup	84
4.9 Eco Wave 	87
4.10 Eco Glow 	87
4.11 Temperature display in degrees Celsius or Fahrenheit	88
4.12 Setting the time	88
4.13 Countdown timer	89
4.14 Child lock	89
4.15 Software version	90
4.16 Remote Model Number	90
4.17 Remote control one button and two button ignition	90
5. Malfunction	91
5.1 Error code F	91
5.2 Resetting the remote control and appliance	92
6. Maintenance	93
6.1 Cleaning the glass pane(s)	93
6.1.1 Easy release door system	93
7. Environment	93
7.1 General	93
7.2 Appliance	93
8. Warranty	93



- | | | | | | |
|----------|---|-------------------|----------|---|-------------------|
| A | - | Countdown timer | F | - | Thermostatic mode |
| B | - | Ignite/Switch off | G | - | Up |
| C | - | Program mode | H | - | Down |
| D | - | Second burner | I | - | Eco wave |
| E | - | No function | J | - | Eco glow |

Button	Display	Description
	OFF	Switching off the appliance > Page 83, Section 4.2
		Igniting the appliance > Page 83, Section 4.1
		Second burner on/off > Page 85, Section 4.6
		Thermostatic mode > Page 85, Section 4.7
		Program mode > Page 86, Section 4.8
		Eco wave > Page 89, Section 4.9
		Countdown timer > Page 91, Section 4.13
		Temperature display > Page 90, Section 4.11
		Setting the time > Page 90, Section 4.12
		Child lock > Page 91, Section 4.14
		Eco glow > Page 89, Section 4.10
		No function
		Battery level indicator > Page 80, Section 3.3
	COM	Remote control pairing > Page 82, Section 3.4
	APP	Drufire App > Page 86, Section 4.8
	H1-L0	High or low fire > Page 84, Section 4.5

1. Safety

A DRU appliance must be installed in accordance with the instructions shown in this document. Carefully read all the instructions and warnings before starting with the installation process. It is the sole responsibility of the installer to make sure this fireplace is installed in compliance with the instructions and all applicable codes. Consult your local inspector to determine the need for a permit or license prior to starting the installation.



WARNING

Precautions/safety instructions

Read these instructions carefully and completely before operating. Failure to follow them could result in a fire or explosion causing property damage, personal injury, or loss of life. Service and installation must be performed by a qualified service technician.

Electric shock hazard

- This control must be electrically wired and operated in accordance with all codes and local regulations.
- Do **NOT** use the control if you suspect it may be damaged.

Safety of the installation

- The appliance is powered by 110VAC 60Hz.
 - Do not make any changes to the appliance.
 - If the appliance ignites with a pop, close the gas shut-off valve and contact your dealer.
 - In case of malfunctions and/or poor performance, close the gas shut-off valve and contact your dealer.
 - Never use the appliance in case of a broken or cracked glass pane. Close the gas shut-off valve and have the glass pane replaced.
 - Make sure that combustible objects and/or materials such as curtains are at a distance from the appliance and/or the flues of at least 31.5" [80 cm] unless indicated otherwise in the installation manual.
 - Clothing or other flammable material should not be placed on or near the appliance. Prevent contact with hot parts of the appliance to prevent burns.
- Do not use this appliance if any part has been under water. Immediately call a qualified service technician to inspect the appliance and to replace any part of the control system and any gas control that has been under the water.
 - Children and adults should be alerted to the hazards of high surface temperature and should stay away to avoid burns or clothing ignition.
 - Due to high temperatures, the appliance should be located out of traffic and away from furniture and draperies.

What to do if you smell gas

- Do **NOT** operate any appliance.
 - Do **NOT** touch any electrical switch; do **NOT** use any phone in your building.
 - Immediately evacuate the area and contact the gas supplier. Follow the gas supplier's instructions.
 - If you cannot reach the gas supplier, call the fire department.
- Installation and service must be performed by a registered gas installer, service agency, or the gas supplier. Installation must comply with local codes or, in the absence of local codes, in accordance with the National Fuel Gas Code ANSI Z223.1/NFPA 54, the IFGC, or CSA B149.1. All piping and tubing must comply with local codes and ordinances.
 - Use only your hand to push in or turn the gas control knobs. Never use tools. If a knob will not push in or turn by hand, do not try to repair it. Call a qualified service technician. Force or attempted repair can result in a fire or explosion.
 - Do **NOT** use a product if you suspect it has been subjected to high temperatures, damaged, tampered with, or taken apart.
 - Do **NOT** use a product if you suspect it has been under water or that liquid has seeped into it. Any of these incidents can cause leaks or other damage that may affect proper operation and cause potentially dangerous combustion problems.
 - The flue restrictor position must be in accordance with the manufacturer's installation instructions and all applicable standards. Failure to follow them could result in a fire or explosion causing property damage, personal injury, or loss of life.
 - Do **NOT** store or use gasoline or other flammable vapors and liquids in the vicinity of this control or other appliances.

Safety of people and animals

- Do not leave children and persons who cannot judge the consequences of their actions alone with a burning appliance.
 - Place the remote control out of reach from children and persons who cannot properly judge the consequences of their actions.
 - Pets and birds in particular can be sensitive to the vapors that are released when heating for the first time. **Keep the room well ventilated.**
 - Children under 8 years of age, persons with reduced physical, sensory or mental capacities and persons with a lack of experience and knowledge may only operate the appliance if supervised by an experienced person or if they have been provided with instructions about how to operate the appliance and have understood the accompanying safety risks
 - Children should not play with or near the appliance.
 - The appliance may only be operated by means of the remote control and/or the DRU Fire App, provided the appliance is supervised.
 - In case of operation by means of the thermostat function, DRU Fire App or home automation system, the appliance may ignite without a direct ignition command. Take measures to prevent damage and unsafe situations in such cases.
 - If the Drufire App is used, measures should be taken to prevent hacking and therefore unintended ignition of the appliance.
 - The appliance was designed for atmospheric and heating purposes. This means that all visible surfaces, including the glass pane, can become hotter than 100°C.
 - It is recommended to always place a suitable physical barrier in front of the appliance when children, older people or persons with reduced physical, sensory or mental capacities are in the same room as the appliance. If these vulnerable people are regularly present in the room without supervision, a fixed guard should be made around the appliance.
- Installation and repair should be done by a qualified service person. The appliance should be inspected before use and at least annually by a professional service person. More frequent cleaning might be required due to excessive lint from carpeting, bedding material, etc. It is imperative that control compartments, burners, and circulating air passageways of the appliance be kept clean.
 - The Micro Mesh Screen designed to reduce the risk of burns from hot viewing glass is provided with this appliance and should be installed. The appliance **MUST NOT** be used without the Micro Mesh Screen in place. If the barrier becomes damaged, the barrier should be replaced with the manufacturer's barrier for this appliance.



CAUTION

- Young children should be carefully supervised when they are in the same room as the appliance. Toddlers, young children, and others may be susceptible to accidental contact burns. A physical barrier is recommended if there are at-risk individuals in the house. To restrict access to a appliance or stove, install an adjustable safety gate to keep toddlers, young children, and other at-risk individuals out of the room and away from hot surfaces.



NOTICE

- If the appliance will not be used for an extended period of time, we recommend removing the batteries from the remote control in order to prevent damage resulting from leaking.
- This equipment has been tested and found to comply with the limits for a Class B digital device, pursuant to part 15 of the FCC Rules. These limits are designed to provide reasonable protection against harmful interference in a residential installation. This equipment generates, uses and can radiate radio frequency energy and, if not installed and used in accordance with the instructions, may cause harmful interference to radio communications. However, there is no guarantee that interference will not occur in a particular installation. If this equipment does cause harmful interference to radio or television reception, which can be determined by turning the equipment off and on, the user is encouraged to try to correct the interference by one or more of the following measures:
 - Reorient or relocate the receiving antenna.
 - Increase the separation between the equipment and receiver.
 - Connect the equipment into an outlet on a circuit different from that to which the receiver is connected.
 - Consult the dealer or an experienced radio / TV technician for help.

Amendment

This device complies with Part 15 of the FCC Rules and with Industry Canada license-exempt RSS standard(s). Operation is subject to the following two conditions: (1) This device may not cause harmful interference, and (2) This device must accept any interference received, including interference that may cause undesired operation. Changes or modifications not expressly approved by the party responsible for compliance could void the user's authority to operate the equipment.

2. General safety instructions

2.1 Front clearance to combustible materials

The zone in front of the appliance has a minimum clearance distance to combustible materials (see Fig. 2-1). This area is measured starting from the face of the Micro Mesh Screen to the space in front of the appliance. Inside the red zone, no materials of any kind are allowed unless stated otherwise. Non-combustible materials may be placed inside the shown blue zone.



WARNING

No materials and objects of any kind are allowed inside the red zone. Non-combustible materials may be placed inside the shown blue zone (see Fig. 2-1)

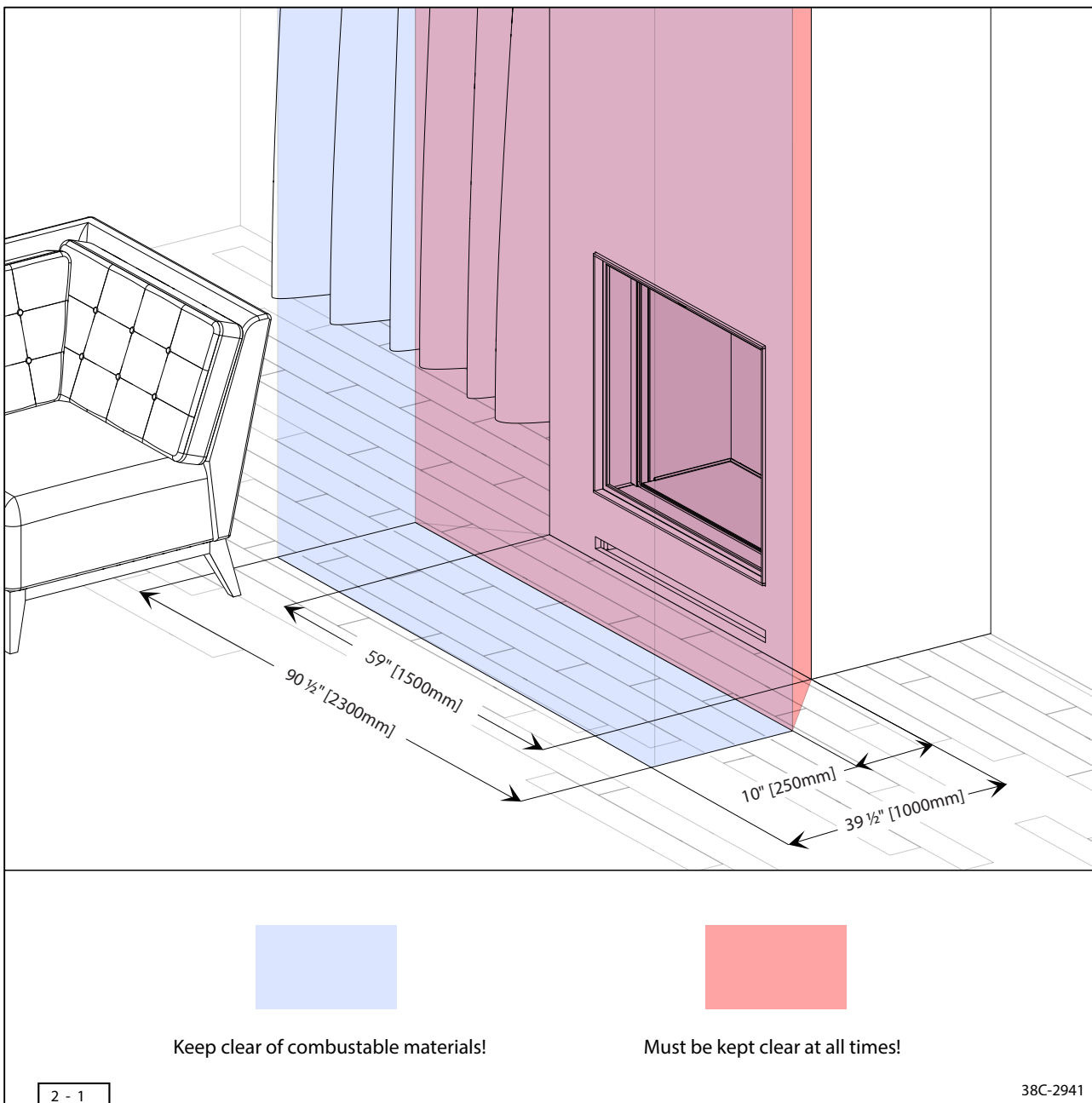

2.2 Putting the appliance into operation

Noises of metal expanding and contracting while heating up or colling down are normal. When starting the appliance, it is not unusual for condensation to occur inside the glass. As the appliance heats up, the condensation will disappear.

- 💡 When starting the appliance, it is possible that condensation occurs on the inside of the glass pane(s). Once the appliance has reached the required temperature, the condensation will disappear automatically.

2.3 Heating for the first time

⚠ CAUTION

- When the appliance is heated for the first time, the flame pattern can be affected and an unpleasant smell may occur as paints and solvents cure. This process may take a number of hours.
 - Keep the room well ventilated.
 - Make sure there are no pets in the room.

💡 NOTICE

- If cultured stone or stucco has been used in finishing of the chase, it should be left to thoroughly dry for at least 6 weeks before putting the appliance into operation.
- Prior to heating for the first time, clean the glass pane(s) (see Section 6.1).
- Prior to putting into operation, the remote control should be linked to the appliance (see Section 3.4).
- Set the appliance to its highest position to speed up the evaporation process.
- Before and after heating for the first time, clean the glass panes in accordance with the instructions to prevent contamination from getting burned into the glass permanently (see Section 6.1).

2.4 Discoloration of walls and ceilings

Discoloration of walls and ceilings can occur, for instance due to convection of dust as a result of too little ventilation, tar substances from tobacco smoke and soot formation as a result of burning atmospheric candles. The problems can be (partly) prevented by properly ventilating the room in which the appliance is located.

3. Operating the appliance

Several methods can be used to operate the appliance. These are described in the sections below.

3.1 Drufire App

The free Drufire App allows you to operate the appliance with an iOS or Android device.

The app is available in the App Store and Google Play Store.



Before the app can be used, the Wifi-module must be wired and plugged into the electrical grid and the app setup must be completed. The Wifi-module can be ordered from DRU separately.



3.2 Home automation

It is possible to control the appliance by means of a home automation system. Consult your dealer for the possibilities.

3.3 Placing/replacing the batteries

The remote works with two AAA alkaline batteries. When the  symbol lights up on the display, the batteries must be replaced. (see Fig. 3-1)

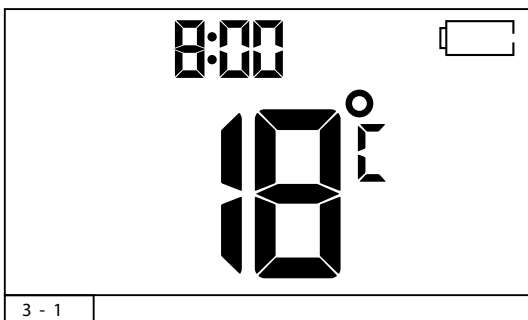

3 - 1

Place and replace the batteries as follows:

- Remove the cover from the battery compartment by pushing it down lightly and sliding it off the remote control (see Fig. 3-2).
- Remove the old batteries from the holder (see Fig. 3-2).
- Place the new batteries in the holder (see Fig. 3-2).
- ⚠ The correct orientation of the batteries to be placed is shown on the inside of the battery compartment.
- Place the cover, slide it upwards and allow it to snap tight to lock (see Fig. 3-2).



WARNING

- Old or dead batteries should be removed immediately. If left in the unit, the batteries can overheat, leak, and/or explode.
- Do NOT expose batteries (including during storage) to direct sunlight, excessive heat, fire, moisture, or severe impact. Each of these conditions can cause the batteries to overheat, leak, and/or explode.
- Batteries must be kept within their recommended temperature limits. (Ambient battery temperature range: 32°F to 131°F [0°C to 55°C].)
- New and old batteries and different brands of batteries must not be used together. Mixing of various batteries can cause the batteries to overheat, leak, and/or explode
- Replace batteries every 2 years or when the low battery indicator appears on the remote control display.
- Hand in the batteries at the collection point intended for this purpose..

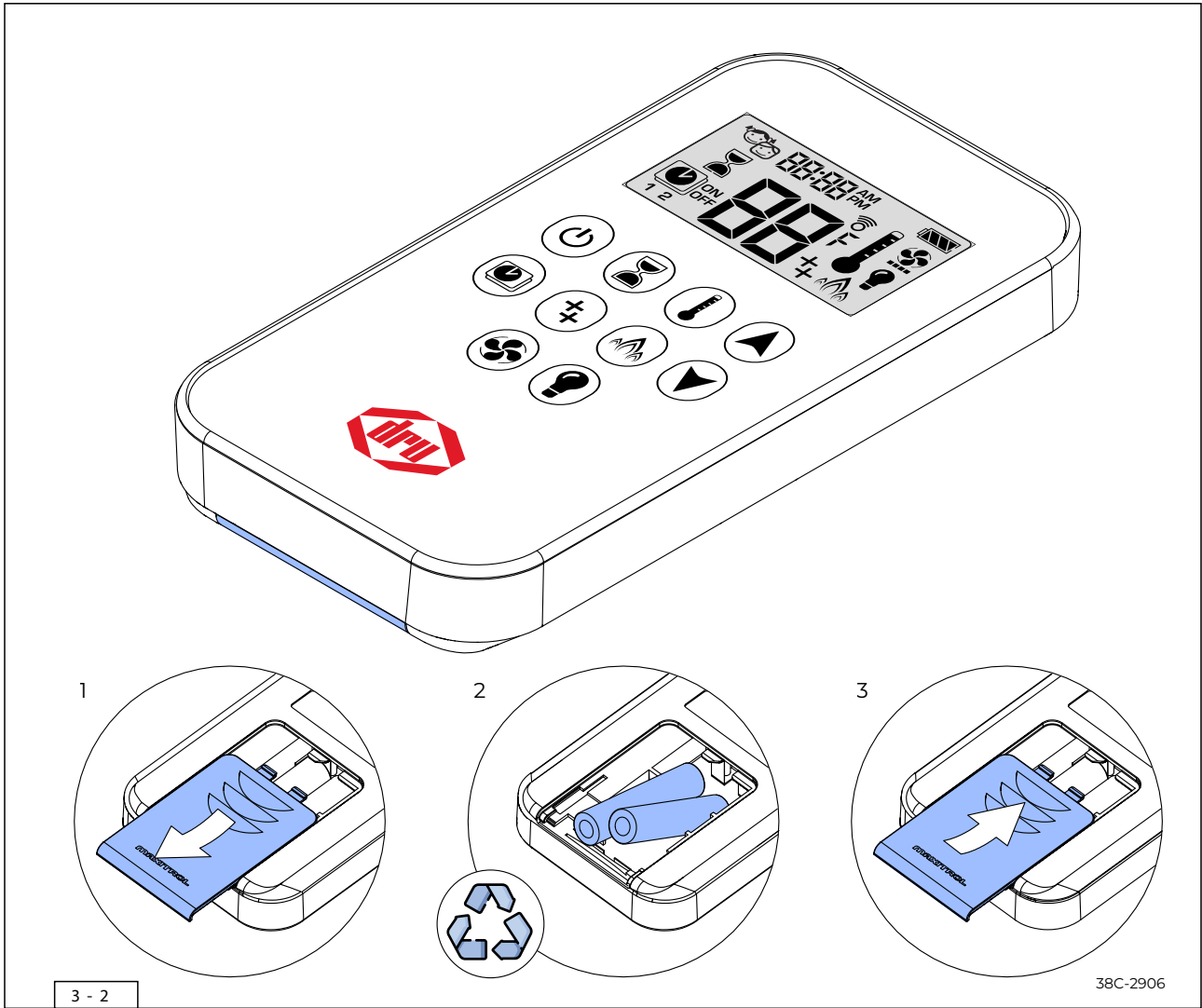

3.4 Remote control pairing

This is a one time setting only and it is not required after changing the batteries in the remote control. Proceed as described below.



DANGER

Do not ignite the appliance until it is fully installed when it comes to the gas connections, vent system and electrical components.



CAUTION

Installation and service must be performed by a qualified gas technician. Check local codes and read all instructions prior to installation.



Connect the electrical grid to the appliance control unit as described in Section 8.3 of the installation manual.



Press and hold the receiver's reset button (see Fig. 3-4) until you hear two (2) beeps. Release the reset button after the second, longer beep. Within the next 20 seconds, press the h button on the remote control. Two (2) short beeps confirm the code is set. is displayed on the remote control confirming the synchronization is in process (see Fig. 3-3). After successful synchronization, the current state of the fire is displayed on the remote control.



- This is a one time setting only and it is not required after changing the batteries in the remote control or receiver.
- Both the receiver and the remote control transmit and receive signals. Remote control and receiver sync status information every 10 seconds during 2 minutes after ignition. After 2 minutes it changes to every 4 - 6 minutes up to 1 hour. Pressing any button on the remote control causes an immediate synchronization.
- The remote control must be located within 26 feet [8 meters] of the receiver.

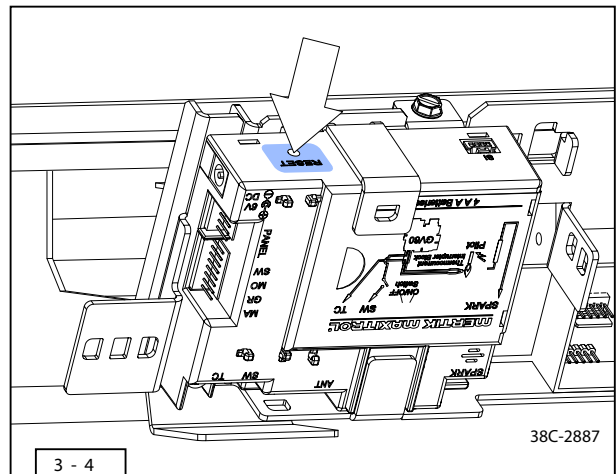
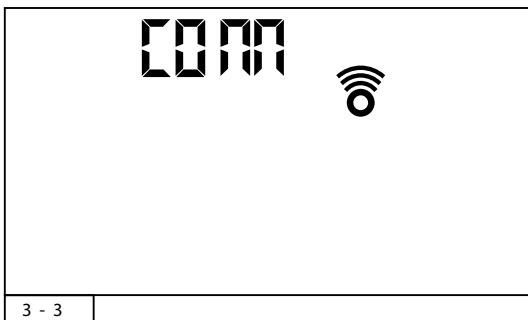

4. Remote control

The appliance is supplied with a remote control. Its functions and possibilities are described in the following sections.

- Press ▲ or ▼ button to enter Manual Mode.
- Press ⏻ button to enter Program Mode.
- Press 🔌 button to enter Eco Mode.

4.1 Ignition 🔌 + ▲

Follow the steps below to ignite the appliance.

WARNING - FOR YOUR SAFETY READ BEFORE LIGHTING

- If you do not follow these instructions exactly, a fire or explosion may result causing property damage, personal injury, or loss of life.
- This appliance is equipped with an ignition device that automatically lights the pilot. **DO NOT** try to light the pilot by hand.
- **BEFORE OPERATING**, smell around the appliance area for gas. Be sure to smell next to the floor because some gas is heavier than air and will settle on the floor.
- When pilot ignition is confirmed, the control unit automatically turns to maximum flame height.

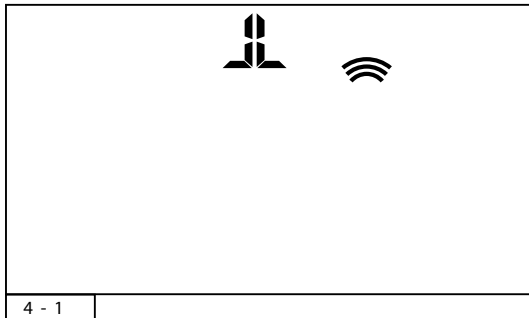

- Press and hold the ⏻ button or the ⏻ and ▲ buttons simultaneously until two short beeps and a blinking series of lines confirm the start sequence has begun; release the button(s). (see Fig. 4-1.)
- Gas will start to flow once the pilot ignition is confirmed.
- The remote control will automatically go into Manual Mode after main burner ignition.

⚠ WARNING

- If you do not follow these instructions exactly, a fire or explosion may result causing property damage, personal injury, or loss of life.
- If the pilot does not stay lit after several tries, turn the main valve knob to the OFF position and contact a service technician. Do not use!

4.2 Switching off the appliance 🔌

Follow the step below to switch off the appliance.

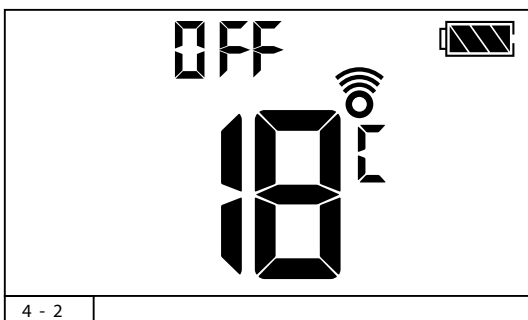

- The appliance can be switched off by pressing the ⏻ button until it beeps. The appliance will switch off immediately.
- 💡 There is a delay, but once the OFF sign stops blinking, the next ignition is possible. (see Fig. 4-2.) This delay can take up to 30 seconds.

4.3 Standby mode (Pilot flame)

Follow the step below to put the appliance in the standby mode so that only the pilot flame is lit.

- Press and hold the ▼ button to put the fire in standby mode.
- 💡 Due to the warmth of the pilot flame, the glass will remain clean longer.

4.4 Flame height adjustment

To adjust the flame height, follow the steps below.

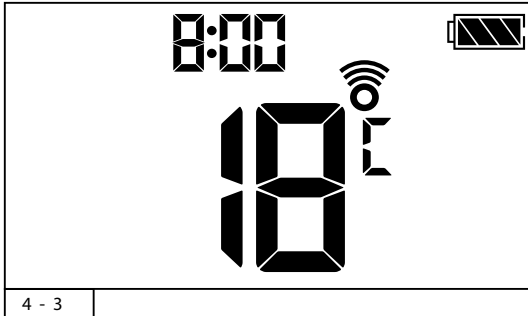

- To increase the flame height, press and hold the ▲ button.
- To decrease the flame height or to put the fire in standby mode, press and hold the ▼ button.

4.5 Designated low fire and high fire

The appliance is fitted with a previously set low and high flame. Follow the next steps to adjust to this previously set flame height.

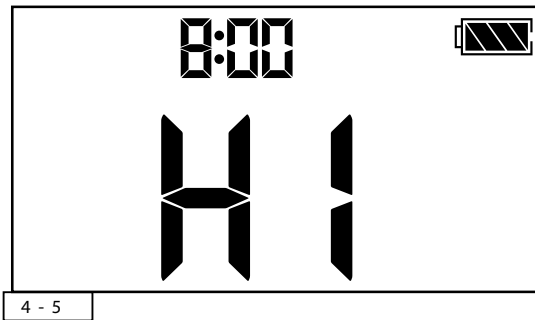
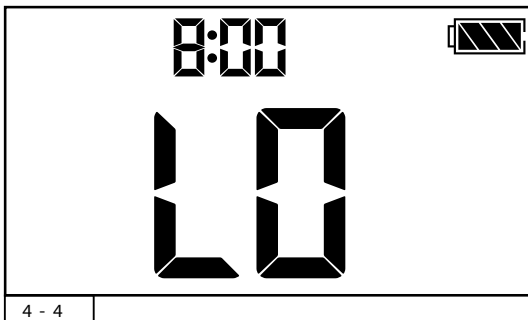

- 💡 The backlight of the remote control display must be on for high fire and low fire double-click operation.
- 💡 Flame goes to high fire first before going to low fire.
- To go to low fire, double-click the ▼ button. LO is displayed. (see Fig. 4-4.) One beep sounds to confirm the designated low fire is now on.
- To go to high fire, double-click the ▲ button. HI is displayed. (see Fig. 4-5.) One beep sounds to confirm the designated low fire is now on.

⚠ WARNING

- If the appliance will not operate, follow the instructions. SWITCH OFF THE GAS TO THE APPLIANCE! Do not use and call a service technician.

4.6 Switching the second burner on/off

The appliance is equipped with 2 burners, upon ignition, the main burner is on and the second burner is in the last used setting.

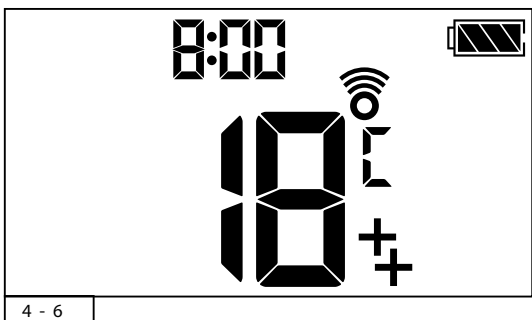

- To switch the second burner on, press the button. is displayed (see Fig. 4-6). One beep sounds to confirm the second burner is now on.
- To switch off the second burner, press the button. will disappear. One beep sounds to confirm the second burner is now off.

4.7 Thermostatic Mode

The room temperature is measured and compared to the set temperature. The flame height is then automatically adjusted to achieve the set temperature.

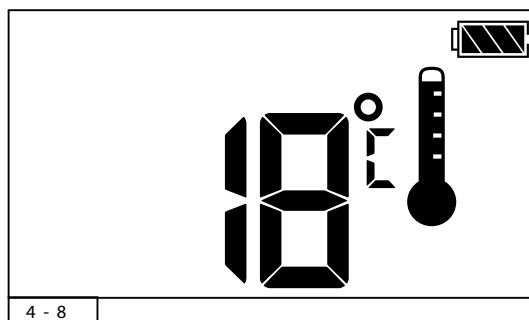
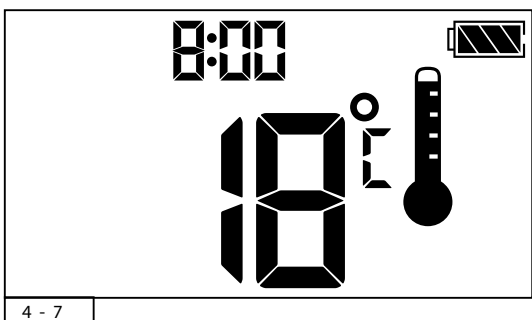

- To turn on the thermostatic mode, press the button. will be displayed, the preset temperature will be displayed briefly, and then the room temperature will be displayed (see Fig. 4-7).
- Make sure the remote control is in the same room as the appliance.
 - The remote control has a temperature sensor to measure ambient temperature. The Drufire App also uses this sensor. For this reason, the remote control must always be placed on a fixed, draft-free location with no direct sunlight.
 - When the second burner (if applicable) is switched off, only the main burner is being regulated.
 - When the set temperature has been reached, the appliance switches off.
- To set the temperature, press the button and hold it pressed until is displayed; the temperature will flash (see Fig. 4-8).
- To adjust the set temperature, press the or button.
- To confirm, press the button or wait.
- To switch off the thermostatic mode, press the button.

4.8 Program Mode



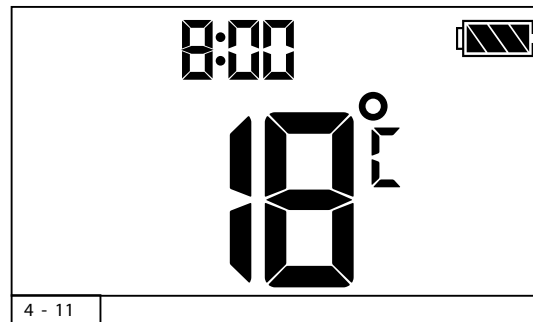
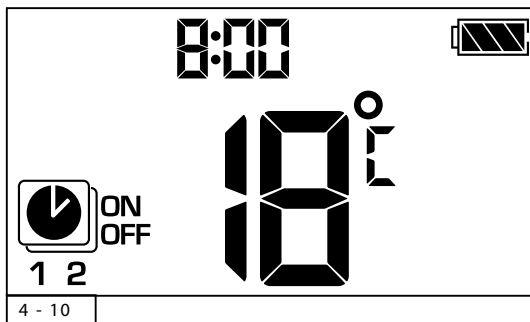
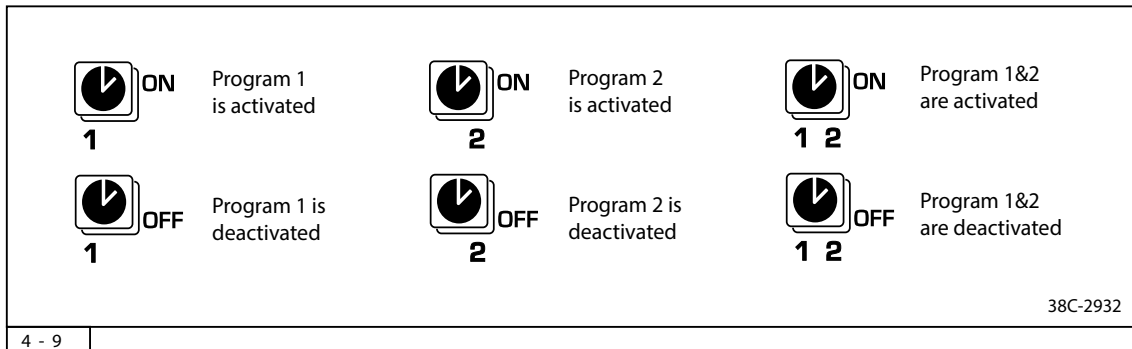

Programs 1 and 2 can both be programmed to turn the appliance on and off at specific times and days, and at a set temperature. The 4 steps described in this section explain how to set a program from start to finish.

4.8.1 Activate/Deactivate Program Mode

Follow the steps below to activate and deactivate program mode with the remote control. Depending on how many programs are set, the symbols on the display may vary. (See figure 4-9)



 During (de)activating the program(s) the symbol on the remote control display will be briefly shown.

- To turn on Program Mode press the  button until , 1 or 2, ON is displayed (see figures 4-9 and 4-10).
- To turn off Program Mode press the  button until , 1 or 2, OFF is displayed (see figures 4-9 and 4-11).

4.8.2 Program Mode Setup

Due to a timer in the remote control, it might be useful to determine what the program must look like ahead of time. Prepare for the following settings:

- The on and off temperature for this program
- The days of the week this program must be active
- The on and off time for this program

-  - PROGRAMS 1 and 2 use the same on and off temperatures for all day settings. Once a new on and/or off temperature has been set, that temperature becomes the new default setting.
- If all day settings are programmed for PROGRAMS 1 and 2, on and off times become the new default times.
- The batteries must be removed to clear the PROGRAM 1 and PROGRAM 2 settings.

Program mode step 1: Setting the temperature

Setting the temperature is the first thing that needs to be done when setting up a program. Follow the steps below to set the temperature.

-  - The on and off set temperatures are the same for each day.
- Default settings:
 - On temperature: 70°F [21°C]
 - Off temperature: "--" (pilot flame only)

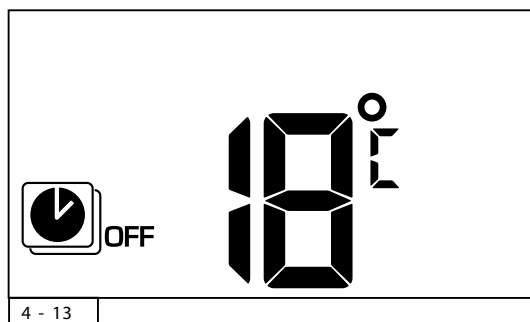
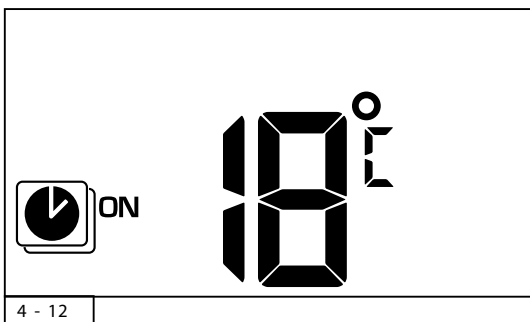

- Press the button and hold it until flashes. **ON** and set the temperature are displayed. This indicates at what temperature the appliance will turn on. (see Fig. 4-12.)
- Select the on temperature by pressing the or button.
- To continue, press the button or wait. **OFF** is displayed, the temperature flashes, and the off temperature can now be set. (see Fig. 4-13.) The off temperature is the temperature at which the appliance will switch itself off.
- Select the off temperature by pressing the or button.
- To confirm, press the button.

Program mode step 2: Setting the day

The second thing that needs to be set up is what day(s) the program needs to be active. There are 3 different options:

ALL Set on and off time for every day of the week. (see figure 4-14)

SA:SU Set on time and off time for both Saturday and Sunday (see figure 4-15).

1 - 7 Unique on and off times may be set for a single day of the week, for multiple days of the week, or for every day of the week (1 is Monday, 2 Tuesday...) (see figure 4-16).

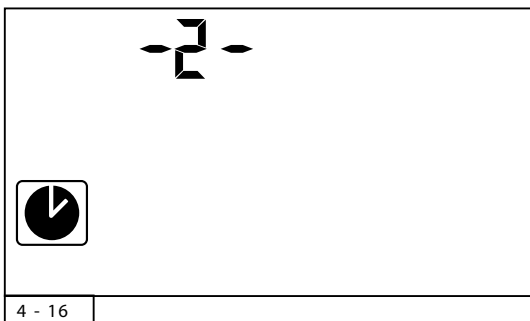
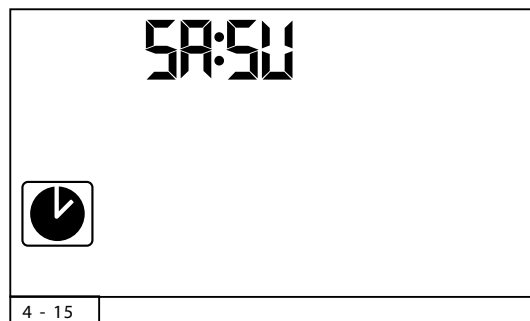
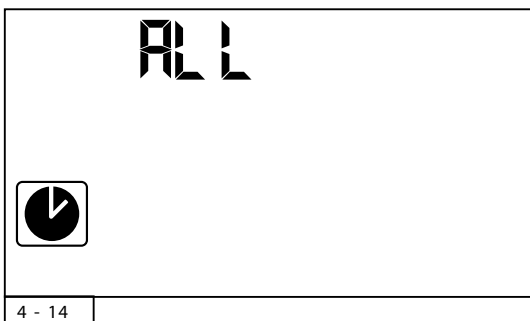

Follow the steps below to set the day:

- After the off temperature is set, **ALL** flashes (see Fig. 4-14).
- Press the or button to choose between **ALL**, **SA:SU**, **1**, **2**, **3**, **4**, **5**, **6**, **7**.
- To confirm, press the button.
- **Continue the program setup in steps 3 and 4 on the next page.**

Program mode step 3: Setting the on time

The on time setting indicates at what time of the day the appliance will turn on. After setting the day, the remote control will automatically go to the on-time setting. Follow the steps below to set the on time.

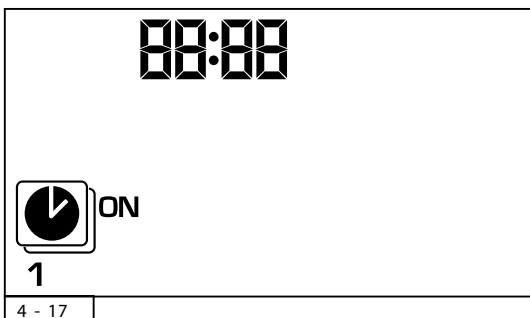

- 1, ON is displayed, the chosen day setting is displayed shortly, and the **hour** flashes (see Fig. 4-17).
- To select the **hour**, press the or button.
- To confirm, press the button. 1, ON is still displayed, the chosen day setting is displayed shortly and the **minutes** flash (see Fig. 4-17).
- To select the minutes, press the or button.
- To confirm, press the button.

Program mode step 4: Setting the off time

The off time setting indicates at what time of the day the appliance will turn off. This setting will automatically be displayed after the on time setting. Follow the steps below to set the off time.

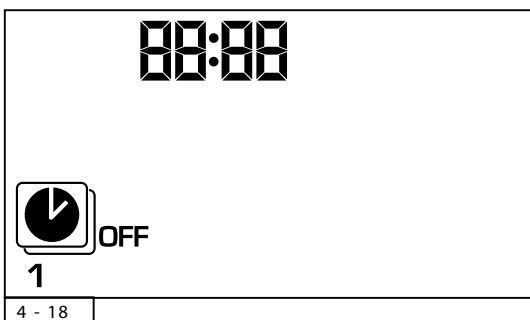



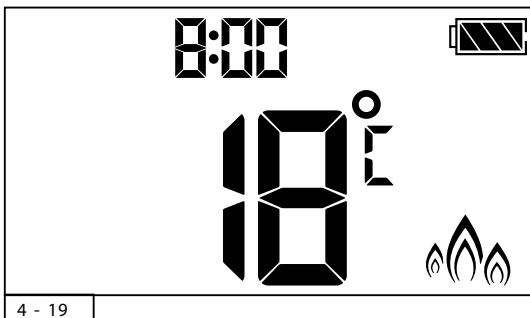

- 1, OFF is displayed, the chosen day setting is displayed shortly, and the **hour** flashes (see Fig. 4-18).
 - To select the **hour**, press the or button.
 - To confirm, press the button. 1, OFF is still displayed, the chosen day setting is displayed shortly and the **minutes** flash (see Fig. 4-18).
 - To select the minutes, press the or button.
 - To confirm, press the button.
- Either continue to PROGRAM 2 and set on and off times or stop programming at this point, and PROGRAM 2 will continue to be deactivated.

4.9 Eco Wave

The flame height modulates between high and low. One cycle lasts approx. 20 minutes.





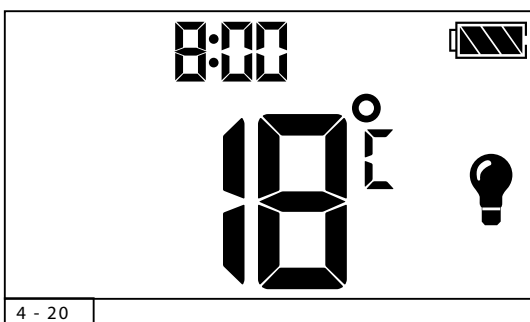

- Press the  button to switch on Eco Wave.  is displayed (see Fig. 4-19).
- To switch off the eco mode, press the  button.  will disappear.
- ⊖ • If the room temperature is lower than the set temperature, the flame height stays on high for a longer period of time.
- If the room temperature is higher than the set temperature, the flame height stays on low for a longer period of time.

4.10 Eco Glow

Eco Glow creates an ambience that mimics the natural glow of burning embers. The LED lights embedded in the fuel bed recreate warmth while minimizing energy consumption. It is possible to switch the Eco Glow lighting on and off even without the burner(s) being used.



- Switch on the Eco Glow lighting by pressing the  button.  is displayed (see Fig. 4-20).
- Switch off the Eco Glow lighting by pressing the  button.  will disappear.

4.11 Temperature display in degrees Celsius or Fahrenheit

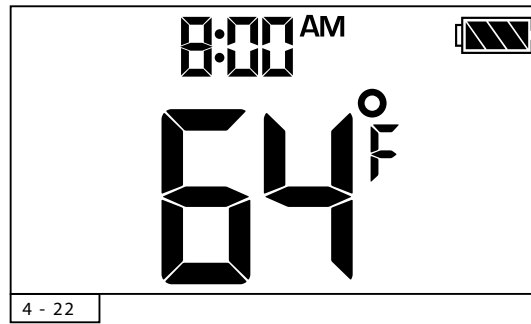
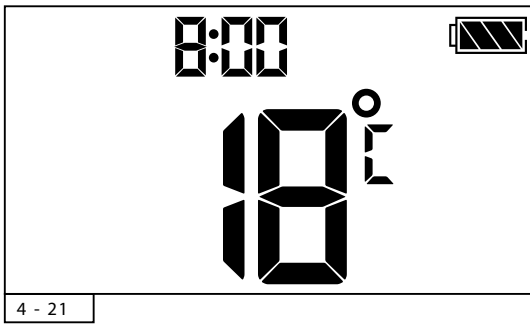

- To change between °F and °C, press and hold and buttons simultaneously. Choosing °C results in a 24-hour clock (see Figure 4-21). Choosing °F results in a 12-hour clock (see Figure 4-22).

4.12 Setting the time

To set or change the time and date on the remote control, follow the steps below.

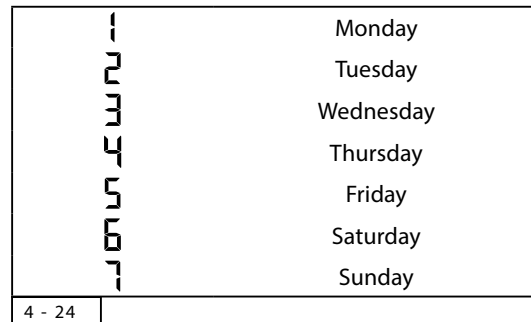
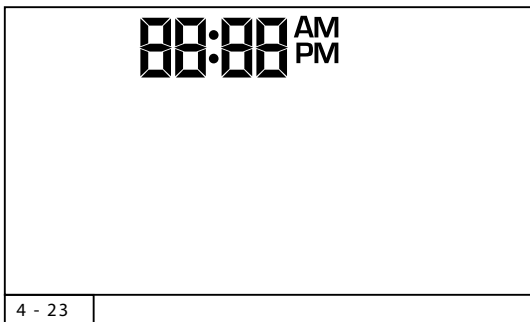











- Press the and buttons simultaneously. **The day** flashes (see Fig. 4-23).
- Press the or button to select a number to correspond with the day of the week (see Fig. 4-24).
- Press the and buttons simultaneously. **The hour** flashes (see Fig. 4-23).
- To select the hour, press the or button.
- Press and hold the buttons simultaneously. **The minutes** flash (see Fig. 4-23).
- To select the minutes, press the or button.
- To confirm, press the and buttons simultaneously or wait.

4.13 Countdown timer

The countdown timer can be used to set a predetermined duration for the fire. The fire will automatically be shut off after the specified time. This offers convenience and energy efficiency.







- To turn on the countdown timer press and hold the  button until  is displayed and the **hour** flashes (see Fig. 4-25).
- To select the hour, press the  or  button.
- To confirm, press the  button. **The minutes** flash (see Fig. 4-25).
- To select the minutes, press the  or  button.
- To confirm, press the  button or wait.
- To switch off the countdown timer, press the  button,  and the countdown time disappears.
- 💡 At the end of the countdown time period, the fire shuts off. The countdown timer only works in the Manual, Thermostatic, and Eco Modes. The minimum countdown time is 10 minutes and the maximum countdown time is 9 hours and 50 minutes.

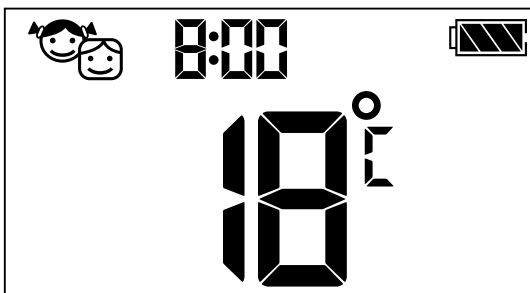

4.14 Child lock

The child lock on the remote control promotes safety and prevents accidental or unauthorized use by children. This reduces the risk of unintended ignition or adjustment of the fire.





- To activate, press the  and  buttons simultaneously. °CL is displayed and the remote control is rendered inoperable, except for the off function (see Fig. 4-26).
- To deactivate, press the  and  buttons simultaneously. °CL will disappear.

4.15 Software version

- Press the  and  buttons simultaneously to display the software version.

4.16 Remote Model Number

- Press the  and  buttons simultaneously to display the remote control model number.

4.17 Remote control one button and two button ignition

- Change from one button to two button ignition (default setting) or vice versa by pressing and holding the  button for 10 seconds immediately after installing batteries. **ON** is displayed and **1** or **2** (one or two button ignition) is flashing. When the change has been made, **1** changes to **2** or vice versa.

5. Malfunction



WARNING

- When the appliance malfunctions, contact a service technician. **DO NOT USE!**
- If the pilot flame does not stay lit after several tries, turn the main valve knob to the OFF position and contact a service technician. **DO NOT USE!**
- If you hear one long beep, this indicates the connection has failed or the wiring is incorrect.

5.1 Error code F

In case of a malfunction of the appliance, the remote control will show an error code as well as the warning and reset symbol. The error codes are indicated with an F in combination with a two-digit code (see Figures 5-1 and 5-2). This error code flashes four times before it disappears from the screen (see Figures 5-1 and 5-2).

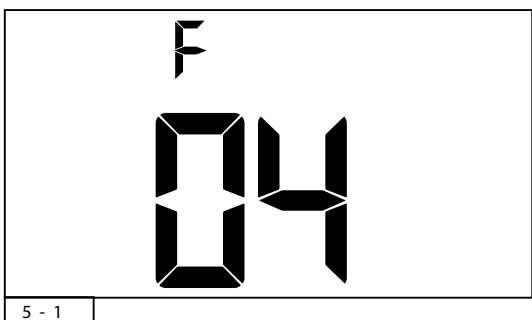

5 - 1

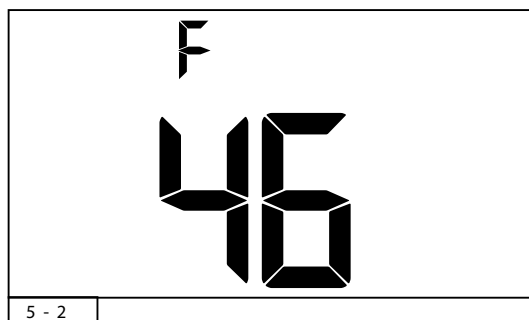

5 - 2



- If the DRU Fire App is used, it is possible to read a wider range of error code(s) with extra information. The error codes with extra information can be found in the app.

Table 5-1: Malfunctions / Error codes Remote

Failure code	Symptom	Possible cause
F04	<ul style="list-style-type: none"> • No pilot flame within 30 seconds (After 3 failed ignition sequences F06 is displayed) 	<ul style="list-style-type: none"> • No gas supply • Air in pilot supply line • No spark • Reversed polarity in thermocouple wiring
F06	<ul style="list-style-type: none"> • 3 failed ignition sequences within 5 minutes • Fire is not responding; no pilot flame 	<ul style="list-style-type: none"> • No gas supply • Air in pilot supply line • No spark • Reversed polarity in thermocouple wiring • Check for correct pilot orifice (LPG to NG or vice versa)
F09	<ul style="list-style-type: none"> • The fire is not responding • No electronic control of fire 	<ul style="list-style-type: none"> • Down arrow button was not pressed during synchronization. • Receiver and handset are not synced
F46	<ul style="list-style-type: none"> • The fire is not responding • Intermittent response • No electronic control of fire 	<ul style="list-style-type: none"> • No or bad connection between receiver and handset • No power at receiver • Low communication range (mains adapter faulty, handset not communicating with receiver)

5.2 Resetting the remote control and appliance

When the appliance malfunctions, it cannot be used and should be reset. Follow the next steps to reset both the remote control and the appliance (see Fig.5-3).

- Press and hold the receiver's reset button until you hear two beeps. The first beep is short and the second beep is long. After the second beep, release the reset button.
 - Take the batteries out of the remote control (Section 3.3).
 - Turn the remote control around and press the ▲ or ▼ buttons until the screen is blank.
 - Put the batteries back in the remote control and connect again to the appliance. (Section 3.4.)
- ⓘ The time and temperature will reset on the remote control.
 - ⚠ Contact your dealer if malfunctions occur repeatedly and/or return.

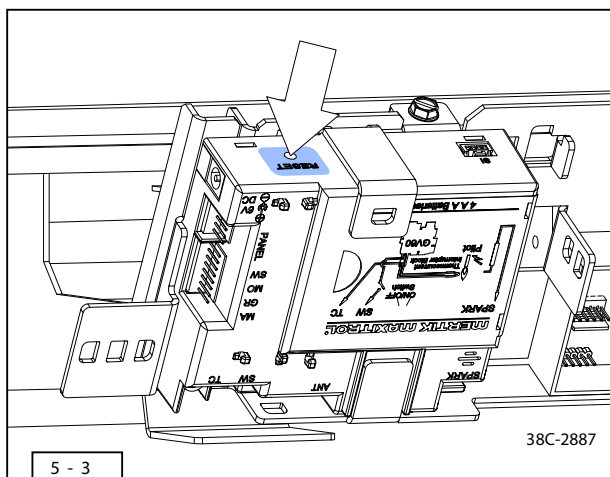

6. Maintenance

We recommend this appliance is cleaned and inspected once a year by a qualified service technician.

- ⚠ - Under no circumstances may a stainless steel concentric system be cleaned (internally or otherwise) with, for example, a steel brush or metal sponge. This will damage the oxide scale as a result of which pit corrosion and/or system leaks could occur.
- Replace remote control batteries after 2 years or when the low battery indicator is displayed on the display.

6.1 Cleaning the glass pane(s)

Contamination that has settled on the glass panes could burn in permanently. To prevent this, the glass panes must be cleaned.

Have the glass pane(s) cleaned on the inside at least once per year by a competent installer to prevent contamination from burning into the glass. If the appliance is equipped with an Easy release door system, it is also possible to clean it on the inside yourself (see Section 6.1.1).

- 💡 In some circumstances, it is possible that the glass pane(s) must be cleaned on the inside more often than once per year.
- ⚠ - Prevent damaging the glass pane(s).
- Prevent/remove fingerprints on the glass pane(s) as these can burn into the glass.
- Only use a microfiber cloth and a glass cleaner that is designed for gas fireplaces when cleaning. Other materials such as (paper) towels and steel wool could cause scratches in the paint and the coating of the anti-reflective glass pane(s).
- Regularly remove any deposits as they can burn into the glass.

6.1.1 Easy release door system

An Easy release door system allows you to open the appliance yourself, so that the glass pane can be cleaned on the inside. The installation manual describes how to do this.

- ⚠ The appliance must be switched off and at room temperature before it may be opened and cleaned.
- During production, transportation and installation, it is possible that dust settles on the glass pane(s) and burns into the glass when put into operation. Clean the glass pane(s) before the appliance is put into operation.
- Clean the glass pane(s) on both sides using a ceramic glass cleaner for gas fireplaces.
- When heating for the first time, contamination is released that may settle on the glass pane(s) as a white deposit. Follow the steps below to prevent this deposit from burning into the glass:
- Clean the glass pane(s) on both sides with a ceramic glass cleaner for gas fireplaces.
- Regularly clean the glass pane(s) on both sides with a ceramic glass cleaner for gas fireplaces when deposits are visible.
- 💡 Gas contains certain components in different concentrations that could cause a white deposit to accumulate on the glass pane(s). This cannot be prevented and DRU cannot be held responsible for this.

7. Environment

7.1 General

Recycle all packaging materials and replaced batteries.

- ⚠ Do not throw empty batteries away as general waste, but hand them in at the collection point intended for that purpose.

7.2 Appliance

The appliance should be processed in a responsible method intended for that purpose.

- ⚠ Do not place the appliance with unsorted waste but bring it to a collection point intended for that purpose.
- 💡 Contact your municipality for information about the available collection streams.

8. Warranty

DRU Verwarming B.V. grants limited lifetime warranty to the original purchaser of this appliance provided the product remains in the original place of installation. All the information of this warranty can be found in the appendix.

Prestige 51

Appendix



Appendix

A. Wifi-module and Drufire App	98
1. Drufire App	98
2. Installation of the Wifi-module	98
2.1 Wifi-module LED Status indicator	99
2.2 Resetting Wifi-module	100
B. Approved vent system terminations	101
C. Home automation	102
1. Modbus	102
1.1 Modbus 1 protocol	102
1.2 Modbus 2 protocol	102
D. Replacement parts	103
E. Diagram for connecting components	104
F. Warranty	106
1. Limited Lifetime Warranty	106
1.1 Conditions	106
1.2 Exclusions	107
2. Limitations of Liability	107
2.1 Warranty	107
2.2 How to Obtain Warranty Service	107

A. Wifi-module and Drufire App

957.954.00

The Wifi-module is optional and available separately. Follow the instructions below and, when installing, use only the part from the Wifi-module installation kit provided. The Wifi-module makes it possible for the appliance to be operated with the Drufire App.

1. Drufire App

In addition to the remote control and with the Wi-Fi module installed, it is possible to operate the appliance using the free DRU Fire App (iOS or Android).



2. Installation of the Wifi-module

In order to make the appliance suitable for operation with the DRU Fire App, the Wi-Fi module must be installed.

- Disconnect the appliance from the power supply and close the gas supply.
- Remove the micro mesh screen from the appliance as described in the installation manual.
- Remove the appliance control cover from the appliance as described in the installation manual.

Proceed as follows to install the Wifi-module (Fig. 1):

- Install the Wi-Fi module on the bracket of the appliance control unit by suspending it from the two hooks (Step 1).
- Connect the Wi-Fi module with the receiver using the communication cable provided (Step 2).
- Use the tie wrap provided to attach the communication cable to the bracket of the appliance control unit (Step 3).
- Switch the appliance on and open the gas supply as described in the installation manual.
- Replace the appliance control cover and the micro mesh screen in the appliance as described in the installation manual.

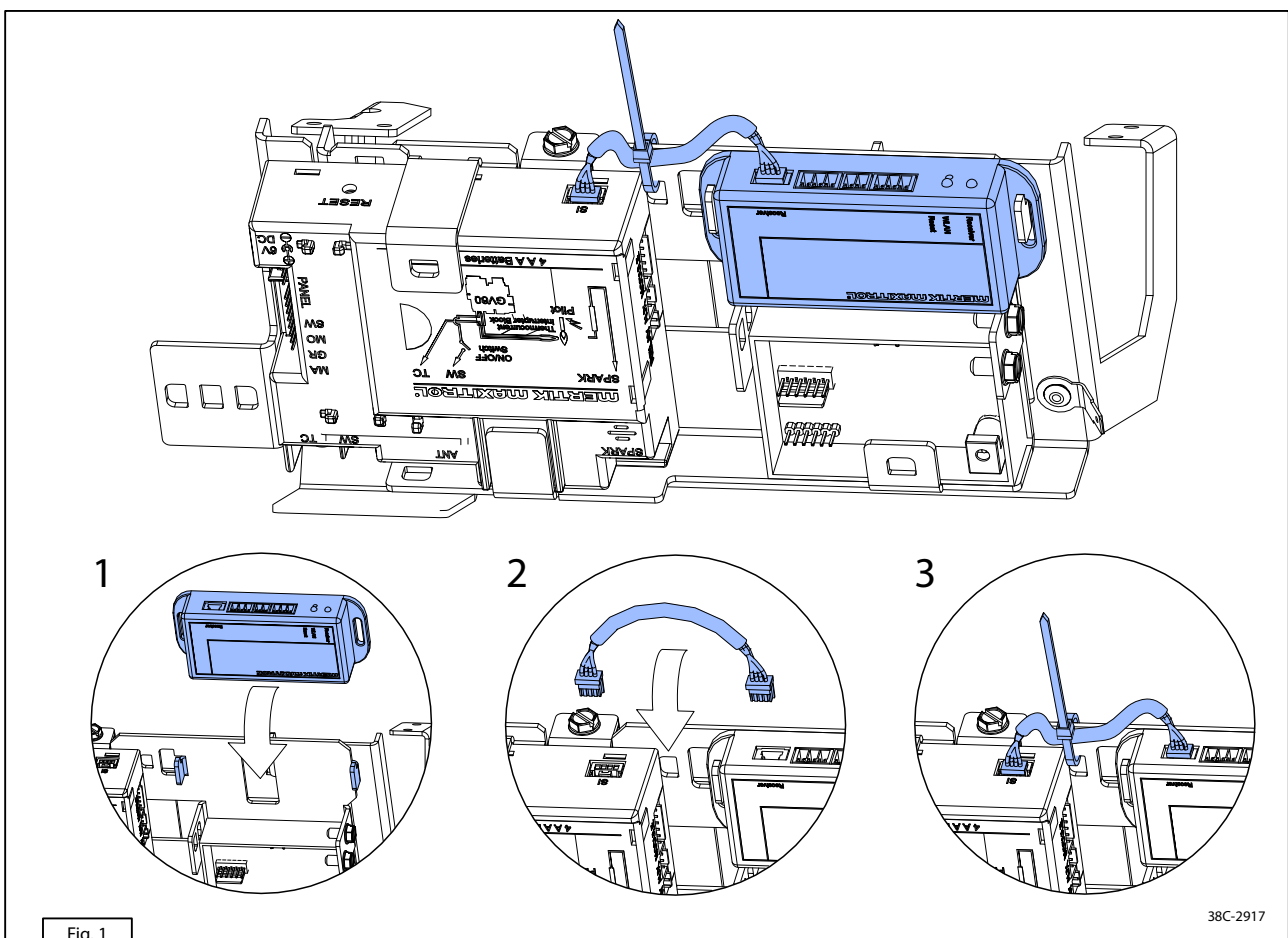

Fig. 1

38C-2917

**NOTICE**

- The active device (Remote control or smart device) is the one last used. An exception is if the non-active device is used to change Light, Fan, or AUX. The non-active device will make the changes, but the active device remains so if it is in Thermostatic, Program, or Eco Mode. If a Profile includes a Thermostatic, Program, or Eco setting it will also cause the active device to remain active.
- If Thermostatic, Program, or Eco Mode is activated using the app, the corresponding program's icon and RPP is displayed on the screen of the remote control.
- **Requirement for wifi router:**
 - Radio frequency: 2.4 GHz band
 - IEEE 802.11n/g/b compatibility
 - WPA2 encryption
- **To connect myfire Wifi-module to Wireless network, make sure:**
 - Home Network signal is in range.
 - Home Network is available.
 - Home Network name and password are correct.
 - SSID of the Wifi Router is not hidden.

2.1 Wifi-module LED Status indicator

The Wifi-module has 2 different LED indicators and a reset button (Fig. 2). The different LEDs with their related colors are listed in Table 1-1.

**NOTICE**

- If no network is configured, the Wi-Fi module will stop accessing the Access Point Mode (AP Mode) after 2 hours.
- If you have multiple appliances using Wi-Fi modules, the minimum distance between the Wi-Fi modules must be 23" [60cm]. A shorter distance may interfere with the data transfer.

Table 1: LED Indications

LED	Color	Status
Receiver LED 1	• Green	Connected to receiver.
	• Red	No data transfer between the receiver and Wifi-module.
	• Off	The standby mode is active or no power supply.
WLAN LED 2	• Green	The wifi connection is safe.
	• Blue/ Green blinking	The access point mode (AP mode) is active.
	• Red	Connection to home network (Wifi router) failed.
	• Off	The standby mode is active or no power supply.

2.2 Resetting Wifi-module

If necessary, it is possible to reset the Wifi-module. Follow the instructions below:

- Select a reset function from Table 2.
- Reset the Wifi-module by pressing the recessed button as described in Table 2 using a suitable tool.

Table 2: Reset status Wifi-module

Press Reset button	LED	Function
Power - on - reset or 1-sec-reset	WLAN LED 2 flashes red, green and blue	If no network is set, the AP mode will be activated for 2 hours. If the network is not set after 2 hours, the Wifi-module will go to the Standby mode. Once a network is set, the Wifi-module will connect directly.
7 secs	Receiver LED 2 flashes every 0.5s in blue	Removes the Wifi settings and turns on the Access Point mode (AP mode) for 2 hours. (Required after replacing the Router or if the Router password was entered incorrectly.)
20 secs	Receiver LED 1 flashes every 0.05s in blue	Deletes all the setup data including the Wifi settings. The AP mode will be activated for 2 hours.

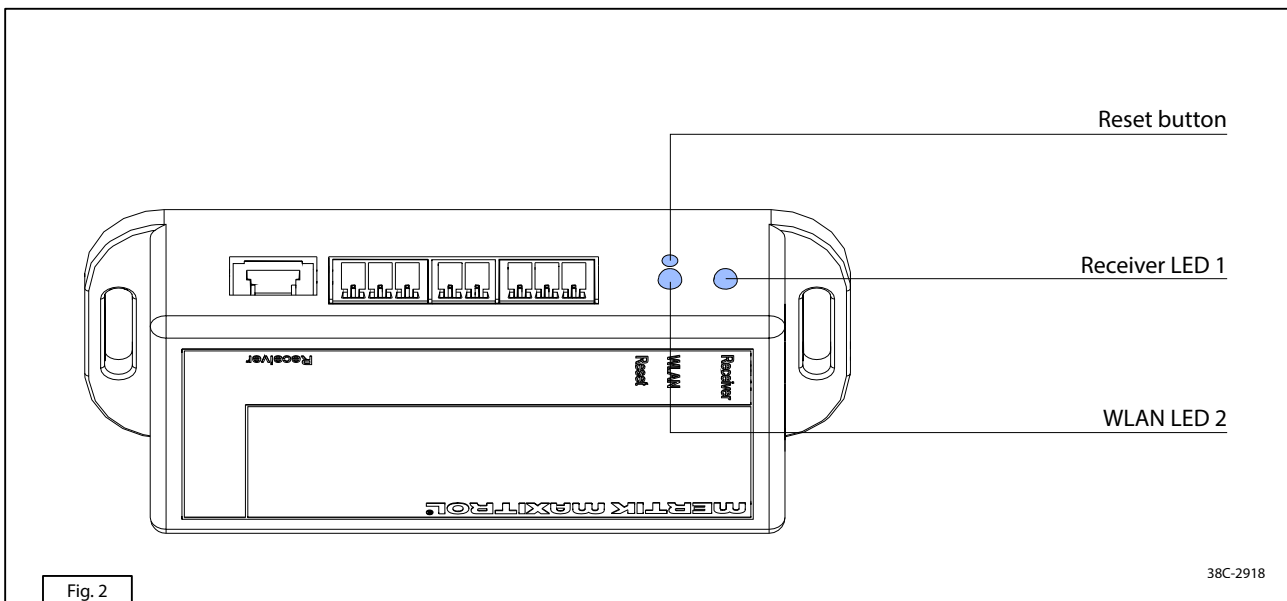

Fig. 2

38C-2918

B. Approved vent system terminations

957.961.00

**WARNING****ONLY** the wall and roof terminals listed in the tables below are permitted to be used with this appliance:**Table 1: Wall terminals**

DuraVent DirectVent Pro (58DVA series)	
58DVA-HSCH	High-Wind Sconce Termination Cap
58DVA-HC	Square Horizontal Termination Cap
58DVA-HSC	Sconce Termination Cap
Selkirk Direct-Temp System (5DT series)	
5DT-AHC	Horizontal Termination 5 x 8"
BDM Pro Form Direct vent system (DVR8 series)	
DVR8-HCP	Pro-Form® Horizontal Co-Axial Pyramid Style Caps for Rigid Pipe
DVF8-HCP	Pro-Form® Horizontal Co-Axial Pyramid Style Caps for Flex Pipe

Table 2: Roof terminals

DuraVent DirectVent Pro (58DVA series)	
58DVA-VCE	Extended Vertical Termination Cap
58DVA-VCH	High-Wind Termination Cap
Selkirk Direct-Temp System (5DT series)	
5DT-VT	Vertical Termination 5 x 8"
BDM Pro Form Direct vent system (DVR8 series)	
DVR8-VCH	Pro-Form® Vertical Round Co-Axial DV Termination Cap

C. Home automation

957.956.00

The appliance is prepared to be connected to an alternative external operating system (home automation). To do so, you need the "Connection cable house management system for Mertik GV60 (26569)". This cable can be purchased separately from the supplier.

⚠ CAUTION

Installation and service must be performed by a qualified installer, service agency or the gas fitter. Check local codes and read all instructions prior to installation.

The following contacts are possible (see Fig. 1):

- **Ignition:** Close contacts 1 and 3 at the same time for 1 second.
- **High fire:** Close contact 1 for 12 seconds.
- **Switching off:** Close contacts 1, 2 and 3 at the same time for 1 second.
- **Igniting the second burner:** Close contacts 1 and 2 at the same time for 1 second.
- **Switching off the second burner:** Close contacts 2 and 3 at the same time for 1 second.

1. Modbus

1.1 Modbus 1 protocol

The external source only has an ON and OFF control. The timer/thermostat handset offers all other functions.

- 💡 The timer/thermostat handset in the thermostat mode controls the room temperature, even if the fire is switched off by an external source. If the handset is in manual mode, the fire switches to high fire in the next cycle of external control.

1.2 Modbus 2 protocol

The external source controls the room temperature. The timer/thermostat remote control must be set to manual mode (or use a standard handset). If the timer/thermostat remote control is set to thermostat mode, it takes priority over the external source.

- 💡 Frequent ON/OFF cycles restrict the service life of the valve and increase the battery use of the remote control. The electrical grid supply can be used rather than batteries.

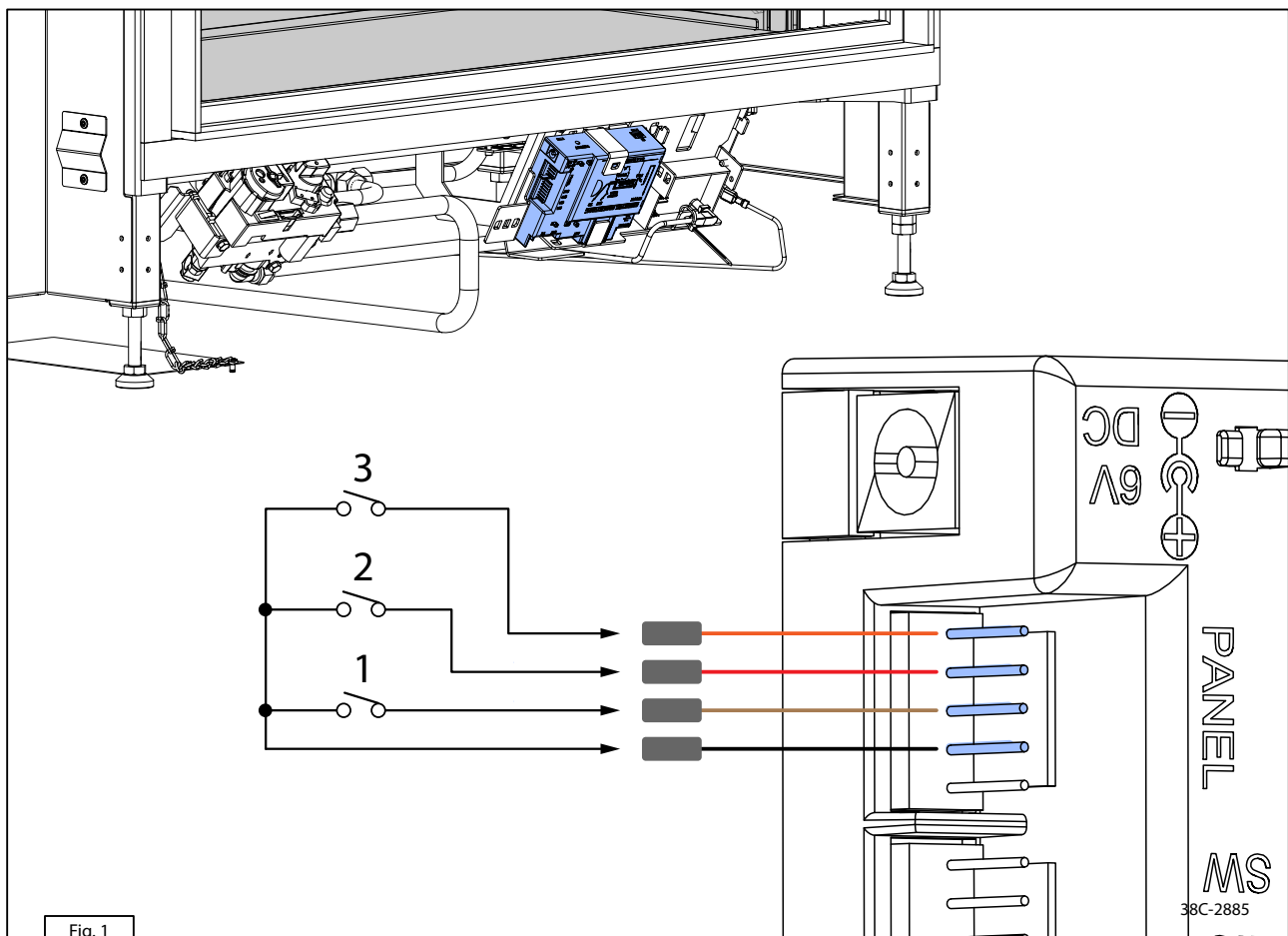

Fig. 1

D. Replacement parts

957.963.00

The available replacement parts are listed below and can be ordered through the dealer.

Table 1: Prestige 51 replacement parts

Art. No.	Product description
805185	Gland nut + olive Ø4 for gas control SIT/Mertik
807267	Control cable (8 wires) Mertik GV60
806280	Thermocouple interrupter M10x1, inside connection
802988	Gland nut Ø12
800068	Compression ring 12mm
918729	Aerosol black paint 400ml
807818	Second thermocouple long for flame detection main burner
26346	Sachet 'ashes' 30ml
807993	Decorative panel Maestro 75/100, L or R, ceraglass-black
808129	Decorative panel Maestro 100 RCH, back, ceraglass-black
992591	Sealing band 20x2 black, self adhesive, per roll of 25m
808638	Coals, grey, 300 ml
808639	Coals, black, 300 ml
808698	PCB with LED lights, DFGT 2 BLE
808699	PCB with LED lights, DFGT 2 BLE, bridge unit
808709	Glow rocks, orange, 500 ml
808819	Gasket for second thermocouple GV60
808827	Gasket pilot burner, GV60, upper
808828	Gasket pilot burner, GV60, under
808825	Pilot burner, GV60
808837	Glass pane Prestige 51, WxH=1027x722
808835	LED driver, for controlling gas LED glow, GV60
808849	Connection cable LED-01, 4-wires, GV60, L=450
992600	Sealing rope diam. 8mm black
808841	Adaptor for LED driver, GV60
808839	Gas control Maxitrol GV60M1-C5B1ML, for Prestige
808797	Solenoid valve, Maxitrol GV-S60C/12
808796	Receiver remote control Maxitrol B6R-RAPT2
808843	Remote control for B6R-HATV4PBD Symax
808844	Connection cable LED driver to receiver, GV60, L=150
808845	Connection cable wifi-module - receiver, GV60, L=150
808846	Thermocouple cable red GV60, spade 4mm, L=500
808847	Thermocouple cable yellow GV60, spade 3mm, L=500
808883	Wire second thermocouple - gas control, GV60, L=500
808884	Wire second thermocouple - remote receiver, GV60, L=500
808877	Wood logs for Prestige 51
9000031	Micro mesh screen, Prestige 51
991056	Adjustable foot M10x80
26549	Fixation screw 4.8x13
808636	Magnet, Ø16
519620	Fixation screw M4x8
991071	Adjustable foot Ø30, M10x80
9000031	Micro mesh screen, Prestige 51
26569	Connection cable house management system for Mertik GV60
991056	Adjustable foot M10x80
26549	Fixation screw 4.8x13
808636	Magnet, Ø16
519620	Fixation screw M4x8
991071	Adjustable foot Ø30, M10x80

E. Diagram for connecting components

957.954.00

This technical schematic overview shows all the components connected to the appliance. These are essential for functionality, safety, maintenance, and problem-solving.



NOTICE

- All components in this diagram shown are for illustration purposes only.
- Components product may vary due to product enhancements.

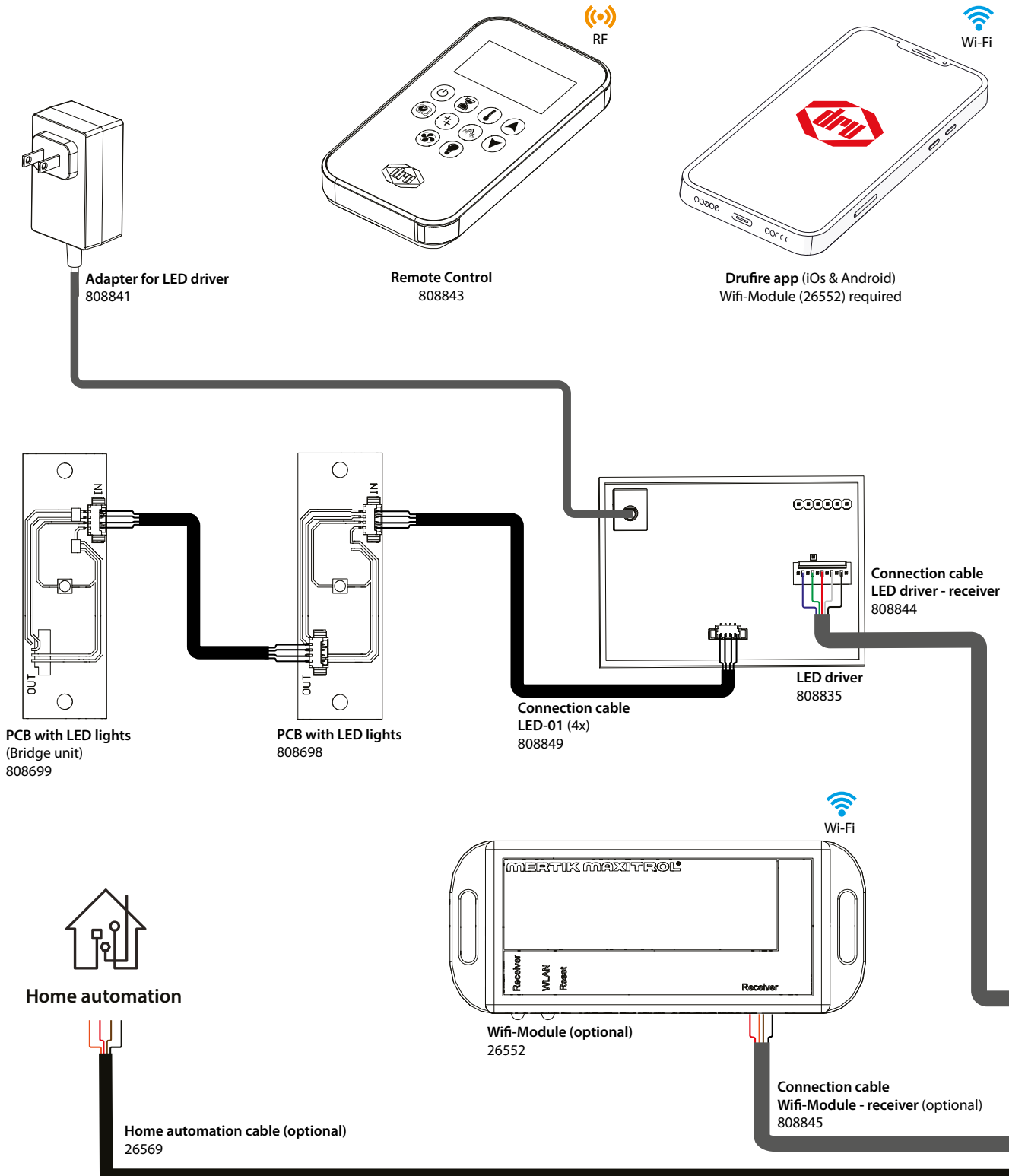

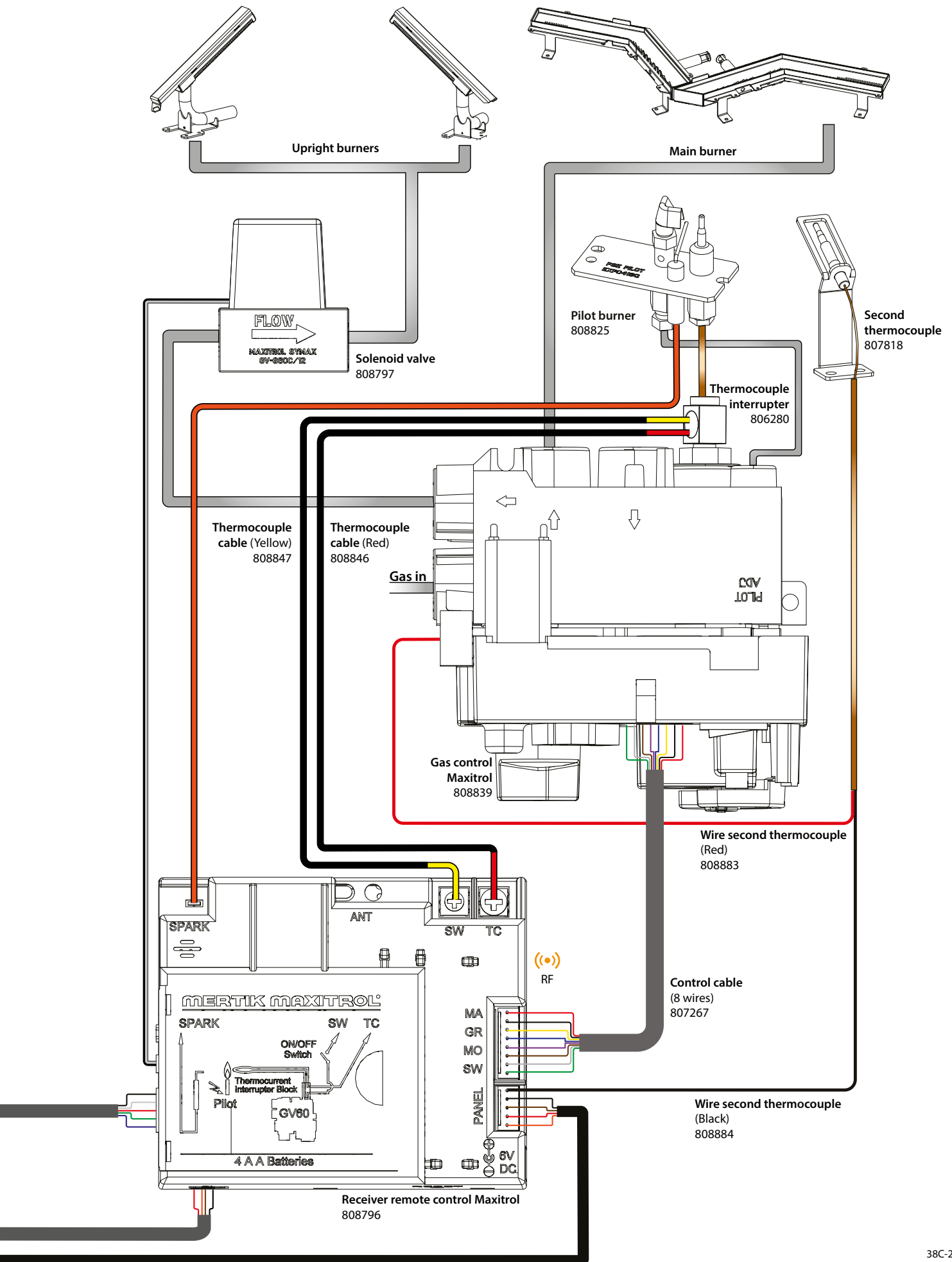

F. Warranty

957.955.00

1. Limited Lifetime Warranty

DRU Verwarming B.V. grants this Limited Lifetime Warranty to the original purchaser of this appliance provided the product remains in the original place of installation. The items covered by this limited warranty and the period of such coverage is explained in the table below. Some conditions apply (see below). The policy is not transferable, amendable, or negotiable under any circumstances.

Table 1: Parts & labor Warranty Coverage

Part	1 year	5 years	Lifetime
Firebox			✓
Steel burner tube		✓	
Glass - Thermal breakage only		✓	
All Surrounds/inlays finishes		✓	
Panels and log set		✓	
Valve assembly and all gas control components, <i>(Pilot assembly, Spark Electrode, Pilot Tubing, Couplings, Thermocouple)</i>	✓		
All Other Electrical components <i>(Ignition Control Boards, Wiring, Switches, Battery Pack, Remote Control Systems)</i>	✓		
Glass panels	✓		
Venting/Venting Components	✓		
All Stainless Steel Surrounds	✓		
All Firebox Media	✓		
All hardware	✓		
Mesh/Glass Safety Barriers	✓		
Glass (crazing)	✓		

1.1 Conditions

The warranty protects against defects in components manufactured or assembled by DRU Verwarming B.V. only, unless specified otherwise herein. Any part(s) found to be defective during the warranty period as outlined above will be repaired or replaced through an authorized distributor, dealer or preapproved and assigned agent, at the discretion of DRU Verwarming B.V. and provided that the defective part is returned to the distributor, dealer or agent for inspection. DRU Verwarming B.V. may at its own discretion fully discharge all of its obligations under the warranty by refunding the verified purchase price of the product to the original purchaser.

All infield diagnosis and service work related to all warranty claims is the responsibility of the authorized selling dealer, or an alternative authorised DRU Verwarming B.V. dealer if preapproved by DRU Verwarming B.V. Negligent service work carried out by unauthorized DRU Verwarming B.V. dealerships, and the costs and results thereof, are not the responsibility of DRU Verwarming B.V.

At all times DRU Verwarming B.V. reserves the right to carry out an inspection of product(s) reported to be defective on location in the field prior to processing or authorizing any claim. Failure to allow this inspection upon request will void the warranty. All warranty claims must be submitted by the dealer servicing the claim, including a copy of the Bill of Sale (proof of purchase by you). All claims must be complete and provide full details as requested by DRU Verwarming B.V. to receive consideration for evaluation. Incomplete claims may be rejected. The product(s) must be installed according to all the manufacturer's instructions as per the manual.

All Local and National required codes must be followed. The installer is responsible to ensure the unit is operating as designed at the time of installation. The original purchaser is responsible for annual maintenance of the unit, as outlined in the owner's manual. As outlined below, the warranty may be voided due to problems caused by lack of maintenance.

Repair/replacement parts purchased by the consumer from DRU Verwarming B.V. after the original coverage has expired on the unit will carry a 90-day warranty, valid with a receipt only. Any item shown to be defective during this time will be repaired or replaced at the discretion of DRU Verwarming B.V.. No labor coverage is included with these parts.

1.2 Exclusions

This Limited Lifetime Warranty does not extend to paint, rust or corrosion of any kind due to a lack of maintenance or improper venting, insufficient combustion air provision, corrosive chemicals (i.e. chlorine, salt, air, etc.), or door or glass gasketing. Malfunction, damage or performance-based issues resulting from environmental conditions, location, chemical damages, downdrafts, installation error, installation by an unqualified installer, incorrect venting components (including but not limited to cap size or type), operator error, abuse, misuse, use of improper fuels, lack of regular maintenance and unkeep, acts of God, weather-related problems from hurricanes, tornadoes, earthquakes, floods, lightning strikes/bolts or acts of terrorism or war are not covered under the terms of this Limited Lifetime Warranty. DRU Verwarming B.V. has no obligation to enhance or modify any unit once manufactured (i.e. as products evolve, field modifications or upgrades will not be performed in existing appliances).

This warranty does not cover dealer travel costs for diagnostic or service work. All labor rates paid to authorized dealers are subsidized, predetermined rates. Dealers may charge the homeowner for travel and additional time beyond their subsidy.

Any unit showing signs of neglect or misuse will not be covered under the terms of this warranty policy and its warranty may be voided. This includes units with rusted or corroded fireboxes that have not been reported as rusted or corroded within three (3) months of installation/purchase.

Units that show evidence of being operated while damaged, or with problems known to the purchaser and causing further damages will have their warranty voided. Units that have had their serial number altered, deleted, removed or made illegible will have their warranty voided. Minor movement, expansion and contraction of the steel is normal and is not covered under the terms of this warranty. DRU Verwarming B.V. is not liable for the removal or replacement of facings or finishing in order to repair or replace any appliance in the field. Freight damages for products or parts are not covered under the terms of the warranty. Products made or provided by other manufacturers and used in conjunction with the DRU Verwarming B.V. appliance without prior authorization from DRU Verwarming B.V. may void this warranty.

2. Limitations of Liability

2.1 Warranty

The original purchaser's exclusive remedy under this warranty, and DRU Verwarming B.V.'s sole obligation under this warranty, express or implied, in contract or in tort, shall be limited to replacement, repair or refund, as outlined above.

In no event will DRU Verwarming B.V. be liable under this warranty for any incidental or consequential commercial damages or damages to property. To the extent permitted by applicable law, DRU Verwarming B.V. makes no express warranties other than the warranty specified herein. The duration of any implied warranty is limited to duration of the expressed warranty specified above. If implied warranties cannot be disclaimed, then such warranties are limited in duration to the duration of this warranty.

Some U.S. states do not allow limitations on how long an implied warranty lasts or allow exclusion or limitation of incidental or consequential damages, so the above limitations or exclusions may not apply to you. Customers located outside the U.S. should consult their local, provincial or national legal codes for additional terms which may be applicable to this warranty.

2.2 How to Obtain Warranty Service

Customers must always contact the authorized selling dealer to obtain warranty service. In the event the authorized selling dealer is unable to provide warranty service, please contact the importer through <http://www.united-buyers-group.com>. Please include a brief description of the problem and your address, email and telephone contact information. A representative will contact you to make arrangements for an inspection and/or warranty service.

Thank you for choosing a DRU Verwarming B.V. fireplace. To provide the best support for your product, we request that the purchase price must be confirmed by the original bill of sale. All claims must be complete and provide full details as requested by DRU Verwarming B.V. to receive consideration for evaluation. Incomplete claims may be rejected.



**Balance between people
and their surroundings**

At DRU, customer satisfaction and efficiency go hand in hand with safety and environmental friendliness.



Premium-quality ambition

We do what we say and say what we do. We are ambitious and critical and continuously improve ourselves.



**The convenience that makes
the difference**

Convenience for the end user is always key. Our focus: working on smart, innovative, comfortable products.



Continuous development

We are curious, keen to learn and forward-thinking. Progress only comes from continuous development

i am
everywhere



DRU Verwarming B.V.
PO Box 1021 | 6920 BA Duiven
Ratio 8 | 6921 RW Duiven
The Netherlands
+31 (0)26 - 319 5 319
www.drufire.com



AMBIANCE®
FIREPLACES | BBQ | OUTDOORS | SPA

United Buyers Group LLC
401 Linn St, 53913 Baraboo, WI
United States of America
+1 608 448 2449
support@united-buyers-group.com
www.united-buyers-group.com



BY APPOINTMENT OF
THE COURT OF THE NETHERLANDS



www.drufire.com

