

JC BORDELET

c r é a t e u r d ' h a r m o n i e

**INSTALLATION, MAINTENANCE AND OPERATION MANUAL FOR EVA 992
CENTRALLY-MOUNTED AND GLASS-ENCLOSED FIREPLACES (painted and
lacquered)**



Tested and approved to ULC-S610 and UL 127 standards by

Manufactured by : BORDELET INDUSTRIE S.A.S. – Z.I. de Lhérat – 63310 RANDAN -
FRANCE



This appliance is:

The manufacturer may update this manual from time to time and cannot be responsible for problems, injuries, or damages arising out of the use or misuse of information contained in this manual.

The installer must read these instructions carefully and, once the installation is complete, turn this manual over to the consumer for future reference.



Instructions Prior to Installation

We recommend that our wood-burning fireplaces be installed and serviced by professionals who are certified in Canada by WETT(Wood Energy Technical Training), in Quebec by APC (Association des Professionnels du Chauffage) or in the United States by NFI (National Fireplace Institute®). Before undertaking this installation, the installer must consult the local building codes and the fire department about installation requirements in the area. A building permit may be required for the installation of this fireplace and the chimney connected to it. Additionally, the homeowner should consult his home insurance company to find out how the projected installation may affect his insurance coverage. The installing contractor must carefully read and understand the installation instructions contained in this manual and follow them to the letter as this will result in a safe, efficient and dependable installation of the fireplace and it's attached chimney. In order to protect the exterior finish of the fireplace and the supplied connecting hardware to the chimney, JC Bordelet S.A.S. have supplied special gloves to be used during the installation so as not to mar the finish of the fireplace and it's related components.

WARNING: Failure to correctly follow the installations guidelines for this fireplace could cause a fire, which could result in loss of life or serious injuries and/or important material damages.

WARNING: Do not use materials other than those provided by the manufacturer for use during the installation as they may be safety hazards and their use could cause a fire, which could result in loss of life or serious injuries and/or important material damages.

WARNING: Do not install this fireplace in a mobile home as it is neither approved nor certified for this type of installation.

CAUTION: Do not attempt to modify or alter the construction of the fireplace or its components. Any modification or alteration of construction may void the warranty, listings and approvals of this system. In that case, JC Bordelet S.A.S. will not be responsible for any injuries or damages.

WARNING: The information appearing on the certification label affixed to the appliance always overrides the information published in any other media (owner's manual, catalogues, flyers, magazines and/or web sites).

TABLE OF CONTENTS

1. SAFETY RULES FOR OPERATING THE FIREPLACE	4
2. THE FIREPLACE	6
2.1 INTRODUCTION	6
2.1.1 Parts Required	6
2.2 FIREPLACE INSTALLATION.....	6
2.2.1 Reinforcing Location-Supporting Frame & Load Bearing Support/ Chimney Connector.....	6
Table 1: Weights Ceiling-Suspended ZELIA 908 Fireplaces.....	7
2.2.2 Installation of Hearth Extension	7
2.2.3 Installation of pipe(s) extension, ceiling cover plate & Fireplace on Load Bearing Support/ Chimney Connector.....	8
2.2.4 Chimney Installation	14
2.2.5 Offset Installation	15
2.2.6 Installation of Anti-Sway Bracket	15
2.3 OPERATING THE EVA FIREPLACE	16
2.3.1 Fuel.....	16
2.3.2 First Fires	17
2.3.3 Building a Fire	17
2.3.4 Dangers of Creosote	18
2.3.5 Maintaining the Fire	18
2.3.6 Combustion Air.....	19
2.3.7 Combustion Settings.....	20
2.3.8 The use of Composite Ecological logs	21
2.3.9 Smoking - Causes and Troubleshooting.....	21
2.4 MAINTAINING THE EVA FIREPLACE AND CHIMNEY.....	22
2.4.1 Fireplace and Chimney Maintenance.....	22
2.4.2 Annual and Seasonal Inspections.....	22
2.4.3 Care and Cleaning of the exterior of the fireplace	23
2.4.4 Disposal of Ashes	23
2.4.5 Glass Care-Cleaning.....	24
2.4.6 Dealing with a Chimney Fire	24
2.4.7 Installing or replacing the sliding and fixed glass panels (and air wash)....	25
2.4.8 Installing or replacing the baffle plate, the ash box and the grate....	28
2.4.9 Replacement Parts list and Combustion Air Intake.....	29
2.5 WARRANTY	31

1. SAFETY RULES FOR OPERATING FIREPLACE

Warning: This fireplace is designed to be operated with all sliding glass panels closed. If they are left open or partly open, flames and firebrands may be drawn out of the fireplace creating risks of both fire and smoke which could result in loss of life or serious injuries and/or important material damages.

1. Teach children fireplace safety rules and do not let children under eight get near the fireplace.
2. Do not use the fireplace under the following conditions:
 - 2.1 Whenever a Vitroceram glass sliding or fixed panel is cracked or broken.
 - 2.2 Whenever any part of the smoke pipe or chimney is loose or not in a proper working order.
3. Never use flammable liquids to light or revive a fire and keep such products away from any heat source. Before lighting a fire, make sure there are no flammable liquids, gases or fumes in the room.
4. Before starting each fire, open the flue damper fully using the glove to turn the key located above the fireplace on the smoke pipe.
5. Open the Vitroceram glass sliding panel(s) with the cool hand tool and the combustion air intake lever located on the lower front of the fireplace.
6. During extremely cold weather, preheat the chimney flue to prevent smoke flow reversal. Hold a lighted rolled up newspaper inside the fireplace towards the smoke pipe for a few minutes.
7. Only use the grate made by JC Bordelet S.A.S. to build a fire. Burn only the quantity of firewood it can hold (Max. 11 kg/ 24 lbs). Never overfire the fireplace, if any part of the fireplace or smoke pipe is glowing red, then you are overfiring. Immediately close the fireplace's combustion air intake lever until the system cools. The high temperature caused by overfiring can permanently damage the fireplace, Vitroceram glass sliding or fixed panels, smoke pipe, chimney and nearby combustible walls and furniture.
8. To prevent deformation of the grate, always leave a minimum 2.54cm (1") of ash in the bottom.
9. When using the fireplace for the first times, make small fires (max. 5.5 Kg /12 lbs) of firewood to give the painted finish of the fireplace and smoke pipe time to cure properly.
10. During the first fires, you may detect certain odors and the coating and oil protecting certain parts may smoke a little. Open a window, to quickly dispel these fumes.
11. Expansion and contraction noises during the heating and cooldown cycle are normal.
12. When the fireplace is in full operation and hot, do not tamper with the damper key or sliding glass panels.
13. Once the fire is out and the fireplace, smoke pipe and the embers have cooled, close the smoke pipe damper (using the glove) and the air intake damper until you prepare the next fire.
14. When cleaning out the ashes, wait until they are cold (min. 24 hours) before removing them. Consult section 2.4.4 on page 15 of this manual for proper procedure. Ashes should be placed in a metal ash container with a tight fitting lid. Pending disposal, the ash container should be placed on a non-combustible floor or outside. If the ashes are buried in soil or otherwise locally dispersed, they should be retained in the ash container until they are cold.
15. Whenever a glass sliding or fixed panel cracks or breaks, stop using the fireplace. To replace broken glass sliding or fixed panels, only use 4 mm (5/32") Vitroceram panels, specifically fabricated for the EVA 992 by JC Bordelet S.A.S. and able to resist temperatures of 750°C (1382 °F).

WARNING: Never use gasoline or gasoline-type lantern fuel, kerosene, charcoal lighter fluid, waste oil or any other combustible liquid to start or rekindle a fire in this fireplace as they may cause an explosion or fire which could result in loss of life or serious injuries and/or important material damages. They must be stored in sealed metal containers in a well-ventilated room or

structure that does not adjoin the room where the fireplace is situated. At all times, keep all other combustible materials at least 1.2m (48") away from the front and sides of the fireplace.

WARNING: When the fireplace is operating, never reach into it for any reason as this may lead to irreversible burns which could lead to loss of life and or serious injuries.

Caution: Never leave children and babies unattended when there is a fire burning in the fireplace. The temperature of the metal surfaces and glass panels can often exceed 100° C (212°F) which may lead to serious burns.

Caution: Never build a wood fire directly on hearth or elevate fire. Always use the grate provided with the fireplace to build a fire. Burn only the quantity of fuel it can hold (Max. 11 kg /24 lbs).

Caution: Do not use this fireplace as a fireplace insert or any other product not specified or approved for use with this fireplace, especially Decorative Gas Fire Log Sets.

Caution: To operate properly, this fireplace needs combustion air, always make sure that there is a sufficient supply of combustion air when operating the fireplace as per ANSI Z 223.1/NFPA 54.

2.THE FIREPLACE

2.1 INTRODUCTION

The EVA 992 fireplace is an energy efficient, heat generating fireplace. It will provide you with a lifetime of comfort and enjoyment provided it is installed, maintained and operated properly.

1- Before beginning the fireplace installation, check the local building codes and obtain a building permit from the local authorities. Have the fireplace installed only as described in this manual and only using components provided by JC Bordelet S.A.S.

2-This fireplace must only serve as a supplementary heat source and JC Bordelet S.A.S. cannot be held responsible for additional heating costs associated with the use of this fireplace. A sufficient and permanent heat source should already be available in the home. It is recommended that the user buy this product from a dealer who can provide installation and maintenance services.

3- To the installer, please read these instructions carefully and, once the installation is complete, turn this manual over to the consumer for future reference.

2.1.1 Parts Required

1- The EVA 992 centrally-mounted fireplace, required lengths of smoke pipe, supporting frame and a load bearing support to connect and support the fireplace, smoke pipe and chimney.

2-A High-Temperature insulated 254mm (10") chimney with all the required chimney lengths and installation accessories certified to the following standards CAN/ULC-S610 (Canadian installations) &UL 103HT (USA installations).

3-Associated components as per these installation instructions.

2.2 FIREPLACE INSTALLATION

2.2.1 Reinforcing Location-Supporting Frame & Load Bearing Support/ Chimney Connector:

1. Before beginning the installation, consult Table 1 for weights of supporting frame, Load Bearing Support/Chimney Connector, total weight of chimney, smoke pipe, fireplace & components.

2. Determine the exact location of the supporting frame and the Load Bearing Support and Chimney Connector above the ceiling in accordance with the proposed location of the ceiling-suspended fireplace so that the fireplace will be perfectly centered in the room below and the lowest edge of the fireplace hood will be 820mm (32-9/32") above the finished floor when the installation is completed.

3. Multiply by two the total weight of all suspended components, including the weight of the supporting frame and Load Bearing Support/Chimney Connector, the chimney, smoke pipe and the fireplace to achieve a minimum 200% structural safety factor when reinforcing the structure around the proposed location of the supporting frame and Load Bearing Support/ Chimney Connector.

**TABLE 1: WEIGHTS CEILING-SUSPENDED EVA 992 CFF FIREPLACE (Approx.)
 (with e.g. ASHT SECURE-TEMP + 10" Chimney - 25mm (1") wall thickness)
 (Height of installation floor to ceiling: Min. 2.43m (8') .**

Weight of fireplace (not including base)	Load Bearing Support & Supporting frame	length of smoke pipe & weight of smoke pipe	Length of chimney & weight (13.35 kg/m - 26.7 lbs/yd. – 8.9 lbs/ft)	Approximate Total weight of installed fireplace
55 kg (121 lbs)	56.5 kg (124 lbs)	2.43m/ 8' Min. height install. No smoke pipe	4.6m to 4.9m (15' to 17') Max. 68.8 kg (151 lbs)	180.3kg (396 lbs)
55 kg (121 lbs)	56.5 kg (124 lbs)	2.73m/ 9' 300 mm(12") 8 kg (17.6 lbs)	10m (33') 133.5 kg (294 lbs)	253 kg (556.6 lbs)
55 kg (121 lbs)	56.5 kg (124 lbs)	4m inside height install. Pipe 1.27m (50.2")long 33.7 kg (74 lbs)	15m (50 Ft) 202.3 kg (445 lbs)	347.5kg (764 lbs)

2.2.2 INSTALLATION OF HEARTH EXTENSION:

1. Remove all combustible floor coverings, e.g. carpeting, linoleum, etc., from the area under where the fireplace is to be suspended.
2. Centered on the planned location of the fireplace, install, flush with the finished floor, a round hearth extension of a minimum diameter of 2.190m (86 ¼ ") and at least 9.5 mm (3/8") thick (backed by a sheet metal plate if over a combustible structure) and made of approved non-combustible material such as ceramic tiles, stone, masonry or concrete flush with the floor. This conforms to applicable standards and is permitted since the bottom of the firebox opening is raised at least 203 mm (8") above the top of the hearth extension.

Diam. 2.190mm (86-1/4 ")



2.2.3 Installing the extension pipe(s), the ceiling cover plate and the Fireplace on the Load Bearing Support/Chimney Connector

1. Make sure that the structure has been sufficiently reinforced as detailed in 2.2.1.

2. Install the supporting frame and Load Bearing Support/Chimney Connector above the ceiling making sure that it is properly situated and aligned so that when the installation is completed the fireplace will be centered on the room below.



2. Install the ceiling cover plate

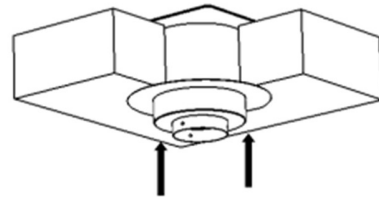

3. For added height, install the required length(s) of smoke pipe onto the Load Bearing Support.

4. Install the fireplace hood onto the smoke pipe with the lower edge of the fireplace hood 820mm (32-9/32") above the finished floor. Make sure that all the fasteners are tight.

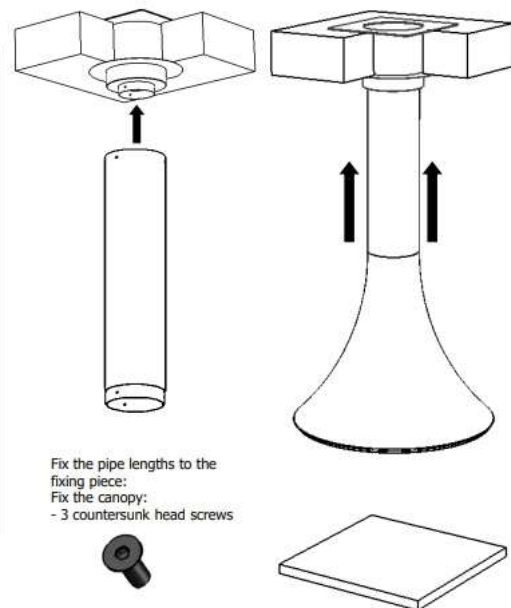

5. Center the base of the fireplace on the Hearth extension in perfect vertical alignment with the hood and bolt it down making sure that the exact 460mm (18-7/64") clearance between the hood and the base is maintained.

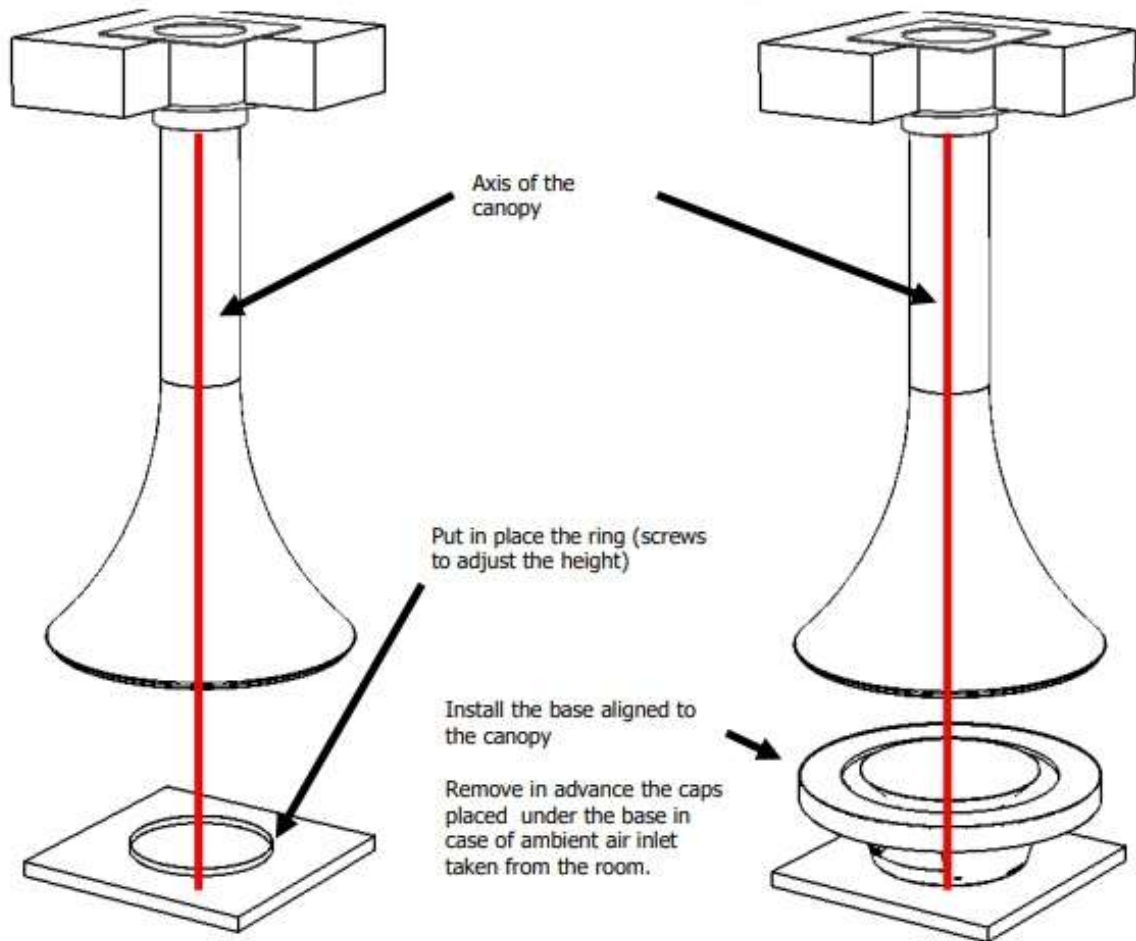

Typical Central Fireplace Installation

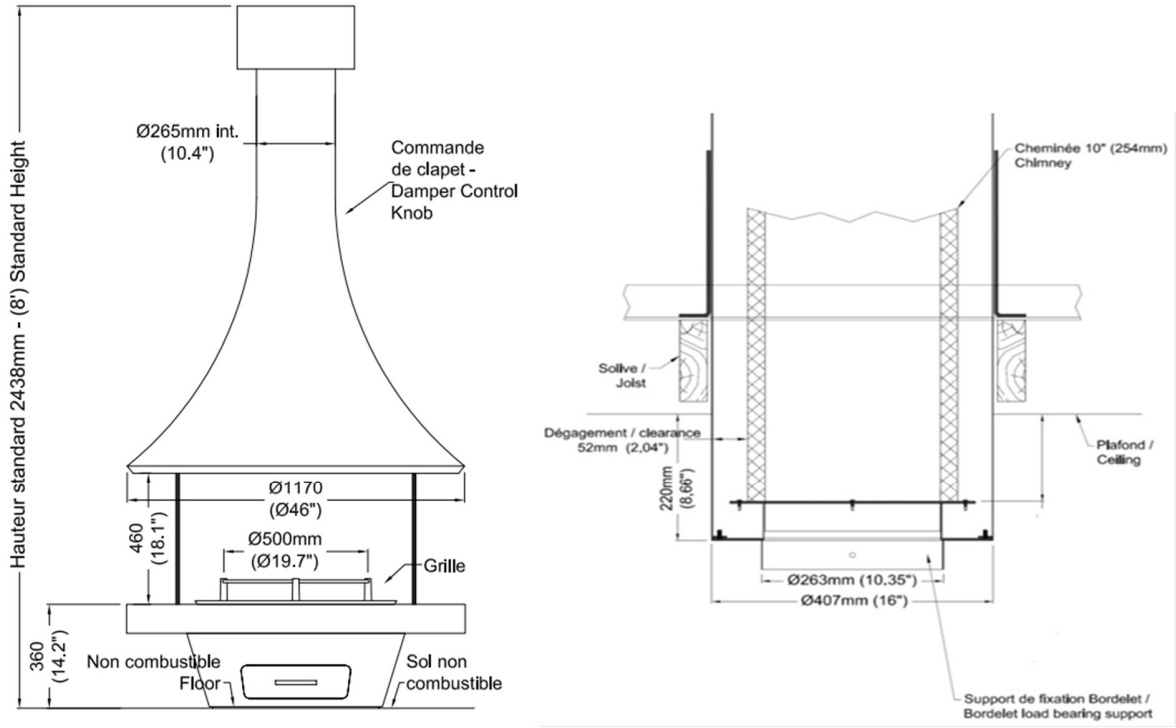

Warning: For centrally-located fireplaces, a minimum clearance to combustibles of 1.2m (48") must be maintained 360 ° around the fireplace. For single wall smoke pipe, a minimum 45cm (18") clearance to combustibles must be maintained and, when connected to the Bordelet Load Bearing Support, a minimum 220mm (8- 11/16") clearance from the top of smoke pipe mounting flange to the ceiling must be maintained, especially with slanted ceilings. Adjust the height of the Load Bearing Support accordingly.

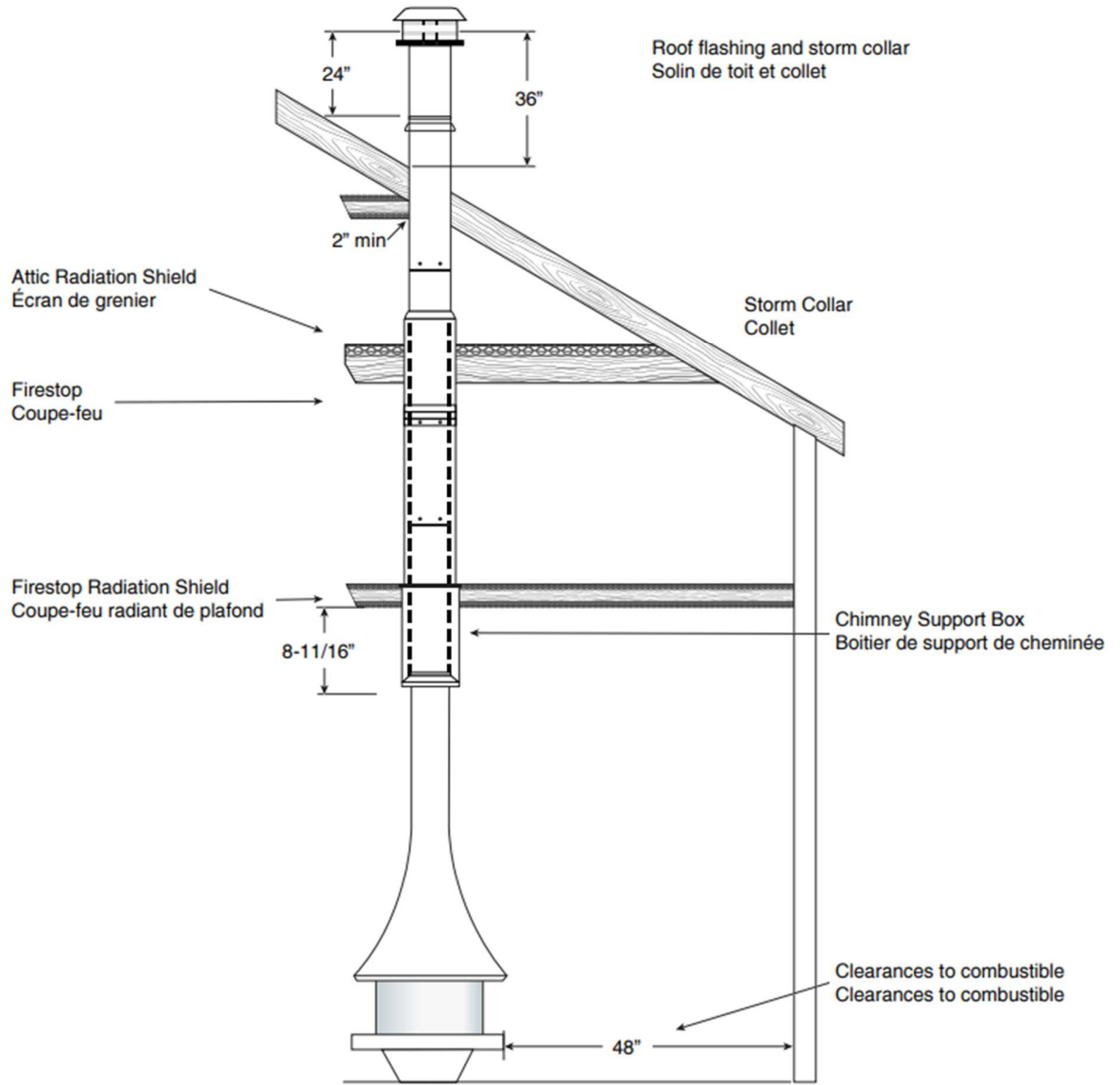

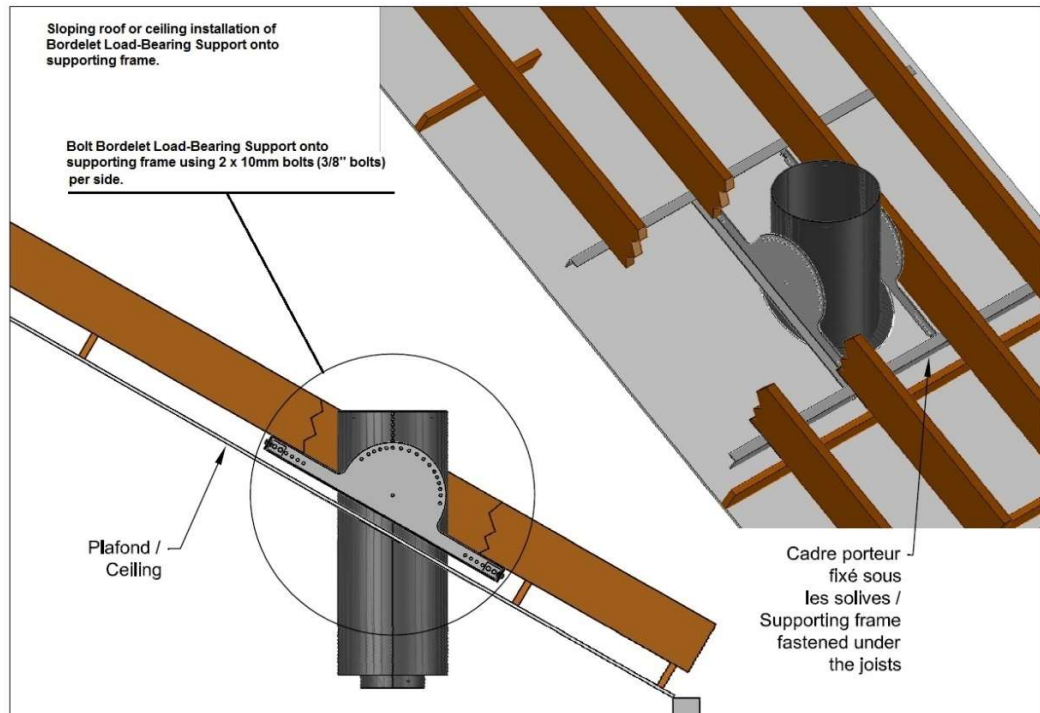
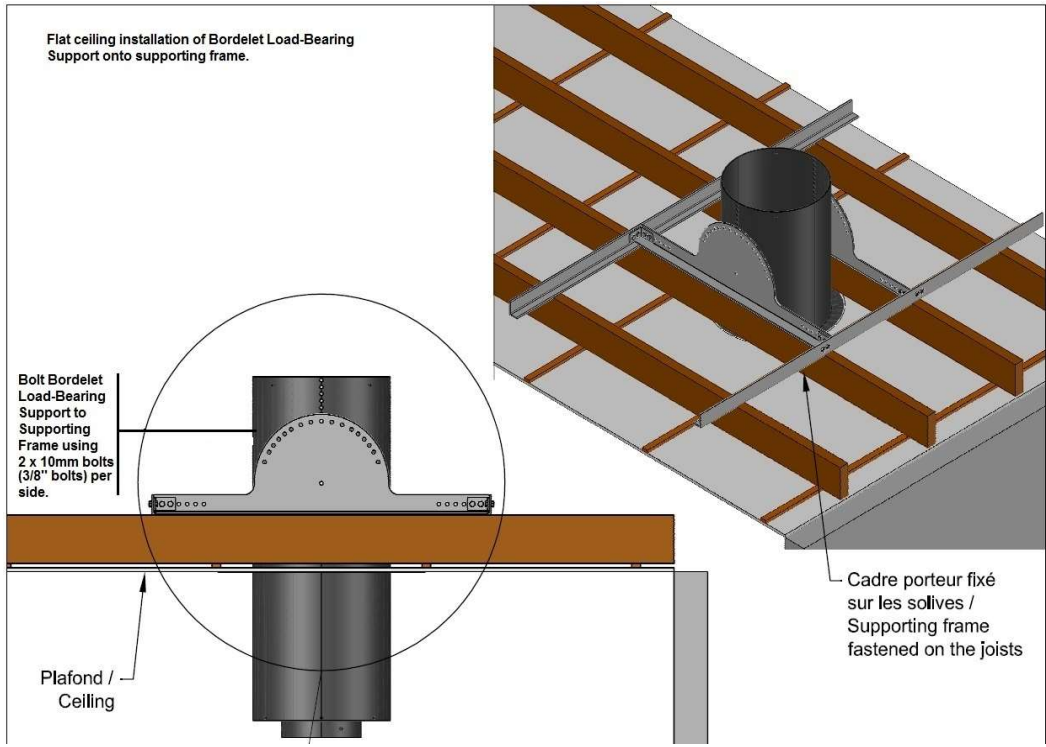

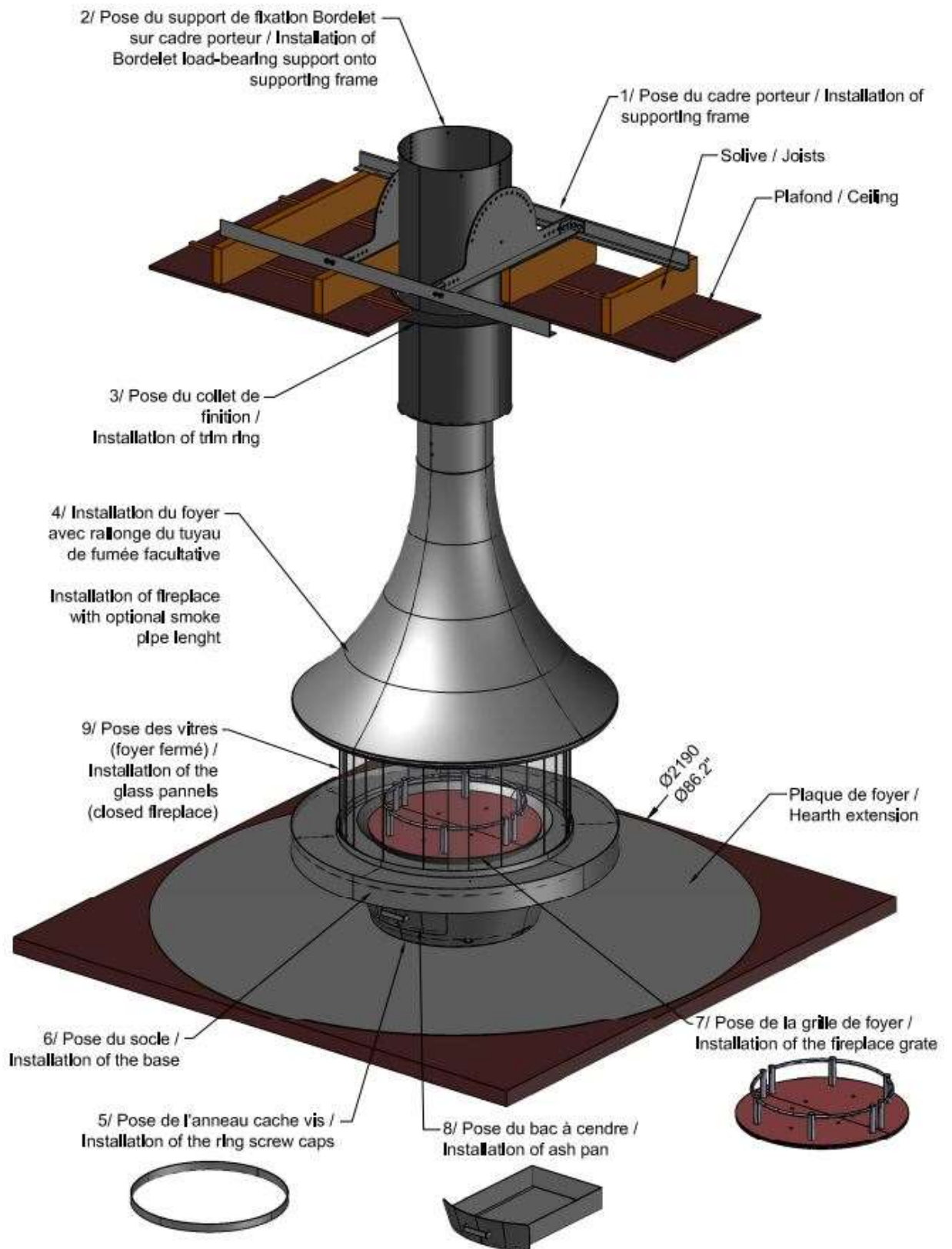

2.2.4 CHIMNEY INSTALLATION:

For optimum performance, the minimum chimney height from the firebox to roof cap is 4.6m (15') to 5.2 m (17'). Additional height will increase draft and decrease the tendency to smoke. If only the minimum chimney height is installed, operating conditions must be optimal; interior chimney, minimum height of 45cm (18") of chimney before any offset, and total respect of the chimney manufacturer installation instructions. There is only one offset permitted in the whole smoke pipe/chimney system, only two 45° elbows are permitted with a straight section connecting them.

10”chimneys approved to CAN/ULC-S610-M87 Std. (Canadian installations)

Security Chimneys International	Oliver Mac Leod	Simpson DuraVent
Secure Temp ASHT + 254mm (10”) - (Ext. Dia. 305mm (12”))	Projet Nova-Temp™ HT6103+254mm (10”) (Ext. Dia. 305mm(12”))	Dura Tech DTC 254mm (10”) (Ext. Dia. 305mm(12”))

10”chimneys approved to UL-103HT Standard (USA installations)

Industrial Chimney Company.	Security Chimneys International
RIS 254mm(10”) (Ext. Dia. 311mm(12 ¼ ”))	Secure Temp ASHT + 254mm(10”) (Ext. Dia. 305mm(12”))

NOTE: NFPA 211 requires that all chimneys used on solid fuel residential applications to be listed to UL 103HT Standard.

Warning: The installer must follow the chimney manufacturer’s installation instructions to the letter. Failure to heed these instructions may cause a fire which could result in loss of life or serious injuries and/or important material damages.

Caution: A chimney servicing a fireplace shall not serve any other appliance. The chimney shall extend at least 915mm (3 ft) above its point of contact with the roof and at least 0.6 m (2') higher than any roof ,wall, or adjacent building within 3m (10 ft) of it. The maximum height of unguided chimney above the roof is 1.5m (5 ft).

2.2.5 Typical Approved Installation of an Offset in JC Bordenet Smoke Pipe

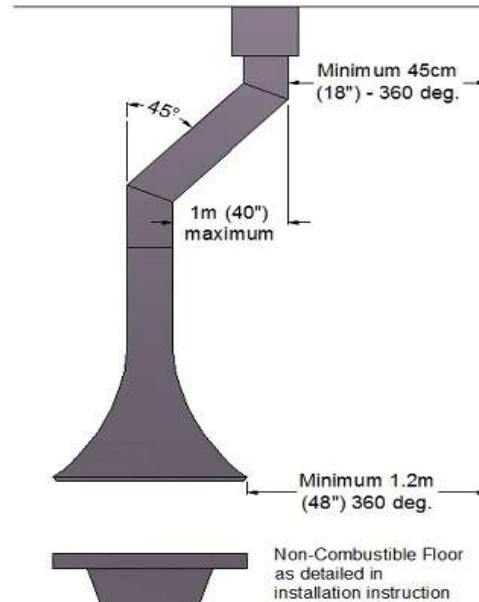

CAUTION: The clearance between the JC Bordenet smoke pipe and unprotected combustible material must not be less than 45cm (18"). The distance between any offset section of the vertical smoke pipe and the ceiling must not be less than 18". The distance from any centrally-located JC Bordenet fireplace to any combustible material is a minimum 1.2m (48") 360° around the fireplace and when connected to the Bordenet Load Bearing Support, a minimum 220mm (8 11/16") clearance from the top of smoke pipe flange to the ceiling must be maintained, especially with slanted ceilings. Adjust the height of the Load Bearing Support accordingly. The complete smoke pipe/chimney system must not have more than one offset composed of two 45° elbows and a straight section connecting them.

2.2.6 Installation of Anti-Sway Bracket

Caution: if the central fireplace and smoke pipe installation reach a height of 4m (13') from floor to ceiling, then an anti-sway bracket is strongly recommended, ideally at about 1.83m (6') to 2.13m (7') to stabilize the installation and prevent oscillations which might, in the long run, loosen fasteners and lead to leaks and failure of the smoke pipe and load bearing support.

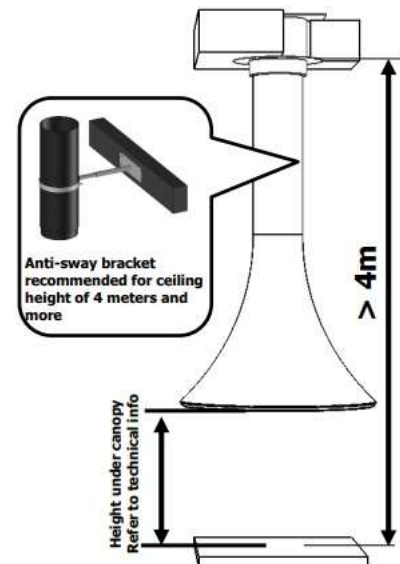

2.3 OPERATING THE EVA 992 FIREPLACE

Before using the fireplace always open the smoke pipe damper (as shown on left) with glove. Once the fire has died down and Before using the fireplace always open the smoke pipe damper (as shown on left) with glove.

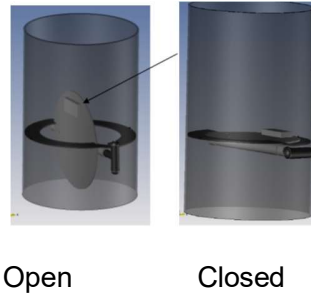

2.3.1 Fuel

Whenever the fireplace is being prepared for use, make sure that the smoke pipe damper and combustion air control are fully open before lighting it. It will work best when fuelled with seasoned cordwood. Hardwoods are preferred to softwoods since the energy content of wood is relative to its density. Select therefore wood that has been air-dried under cover for at least two years and has a moisture content of 15% maximum. Hardwoods will result in a longer burning fire and less frequent refuelling. These hardwoods are highly recommended: maple, oak, hickory, beech, cherry and apple.

These whitewoods are also recommended although they burn more quickly: ash, birch, cedar, elm, hemlock, pine, poplar, linden tree. Excessively wet or green wood is not recommended and will be extremely difficult to burn and will result in lower efficiency, increased creosoting and tarry deposits on the glass panels and in the chimney.

Caution: In order to prevent damage to the fireplace/chimney system, do not fuel it with scrap or garbage, wood chips or granules, sawdust, treated wood, painted wood, wood treated with creosote or chemicals, any paper or cardboard or construction material such as pressed wood, plywood, lumber or driftwood from the ocean which may contain salt or other chemicals which will corrode the metal components of the fireplace and chimney.

Warning: Do not burn coal as smouldering coal may create carbon monoxide causing illness or even death to human beings and pets. The sulphur in coal will also corrode the fireplace and smoke pipe.

Warning: Only place wood logs on top of the grate to allow proper combustion air flow and to prevent damage to the Vitroceram sliding and fixed glass panels. Do not overfire this fireplace, (Max. 11 kg/24 lbs) of firewood, as it may overheat causing a hazard, permanent damage to the fireplace or in the presence of creosote, even igniting a chimney fire which may destroy the chimney and damage the structure.

2.3.2 First Fires

The fresh paint on the fireplace needs to be cured to preserve its finish and quality. For the first 40 hours of operation, only burn small quantities of wood in the fireplace (max. 5.5 kg /12 lbs) and do not build a full fire during this period. Always start your fires as stated in section 2.3.3. Even with a small fire, there will be a strong burnt odor and some smoke during the first fires so properly aerate the room where the fireplace is located. After the initial 40 hours of operation or once the smell of burning paint or grease is finally gone, at each fire gradually increase the quantity of wood being burnt to the maximum of 11 kg/24 lbs) to slowly cure the paint on the fireplace and smoke pipe.

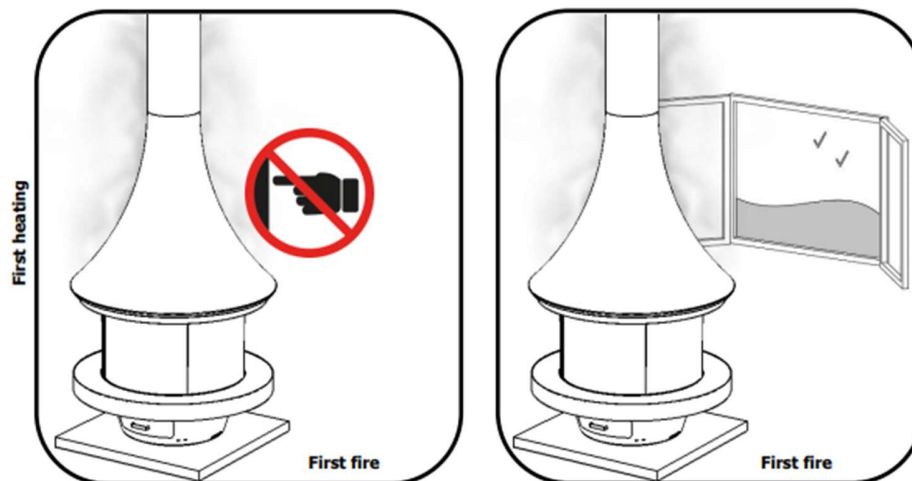

2.3.3 Building a Fire

To start a fire, open the sliding glass panels with the cool hand tool, making sure that the ashes have had 24 hours to cool, then clean-out surplus ash leaving a minimum 2.5cm (1”) of ash to protect the grate, open the smoke-pipe damper, and follow the reverse lighting procedure set out below to light your fire. In this way, the fireplace and the chimney are gradually heated and it's easier to prime with the draft. Also, this principle is more environmentally-friendly than a conventional fire lighting procedure and it reduces pollution caused by combustion gasses (in conventional processes, those gasses given off by large logs in a still cold firebox cannot be burnt). Place the logs on top of the grate then criss-cross several pieces of dry kindling in the firebox on top. Criss-crossing or arranging the fuel so that air can get underneath, will help the fire to get started easily. Once the logs are well ignited, close the sliding glass panels with the cool hand tool and adjust the combustion air intake lever to its maximum position.

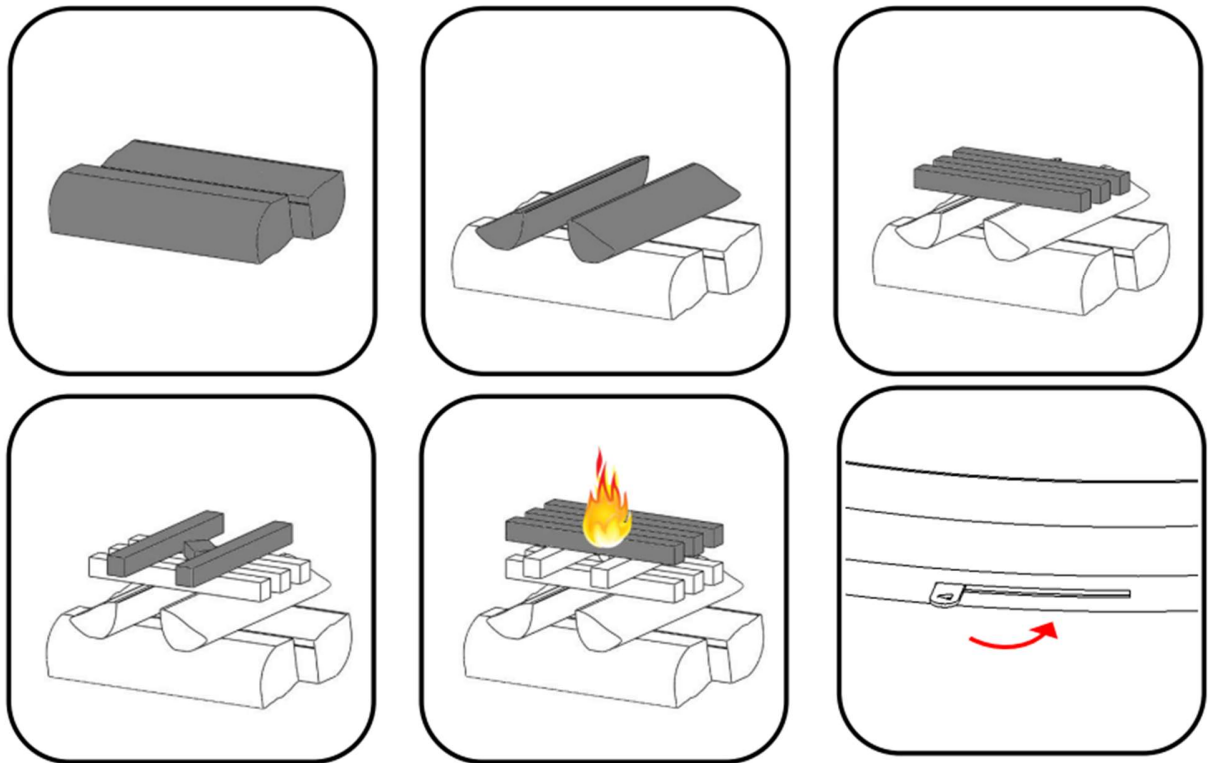

REMINDER: The ignition of the appliance must be carried out using this ignition method (reverse ignition).

2.3.4 Dangers of Creosote

When wood burns slowly or if it is not properly dry, it produces tar and other organic vapors which combine with humidity to produce creosote. Creosote vapor condenses in the chimney left relatively cool by the slow fire and coats the inside of the flue with a very flammable residue. When creosote ignites, it produces a red-hot, extremely dangerous fire which can damage the whole installation and even set fire to a home. At least once a week, it is recommended to make a brightly burning fire rather than a lazy, smoldering fire. Not only will it keep the sliding and fixed glass panels, smoke pipe and chimney cleaner but, what is most important, it will lessen the likelihood of chimney fires.

Caution: During the heating season, the chimney and smoke pipe need to be inspected at least twice to determine if a creosote or soot has built-up above the safe limit of 3mm (1/8"). If creosote or soot accumulation exceeds 3mm (1/8"), immediately have the chimney and smoke pipe swept to lessen the risk of a chimney fire.

2.3.5 Maintaining the Fire

Once the wood has been partially consumed and there is a good bed of embers, proceed to reload the fireplace. Open the air control to its maximum for approximately 15 seconds prior to opening the sliding glass panels. Then, with cool hand tool, open the sliding glass panels by 51 to 102 mm (2" to 4") for 10 seconds before opening them completely. This will increase the draft and thus eliminate the smoke which is stagnant in the fireplace. Then reload the grate of the fireplace with

fresh wood. The EVA 992 fireplace will work best if a thick bed of hot embers is maintained in the bottom of the firebox, and two large or three medium pieces of seasoned wood are added (Max. 11kg/24 lbs). Combustion efficiency is largely related to establishing a hot ember bed, and hot firebox temperatures. The quicker the fireplace and chimney get up to normal operating temperatures, the better. A small intense fire is preferable to a large smouldering fire, both to improve combustion efficiency and to reduce the amount of creosote build-up. The best performance will be obtained by adding fuel to a well-established ember bed, and then operating with the air inlet control open long enough to achieve a hot fire. Use a poker to make an air channel in the embers below the wood to allow combustion air to flow under the wood for a more efficient burn. Once the desired intensity of fire has been reached, the combustion air control can be set to a medium setting, this will result in cleaner glass, less creosoting, greater efficiency and a longer lasting fire.

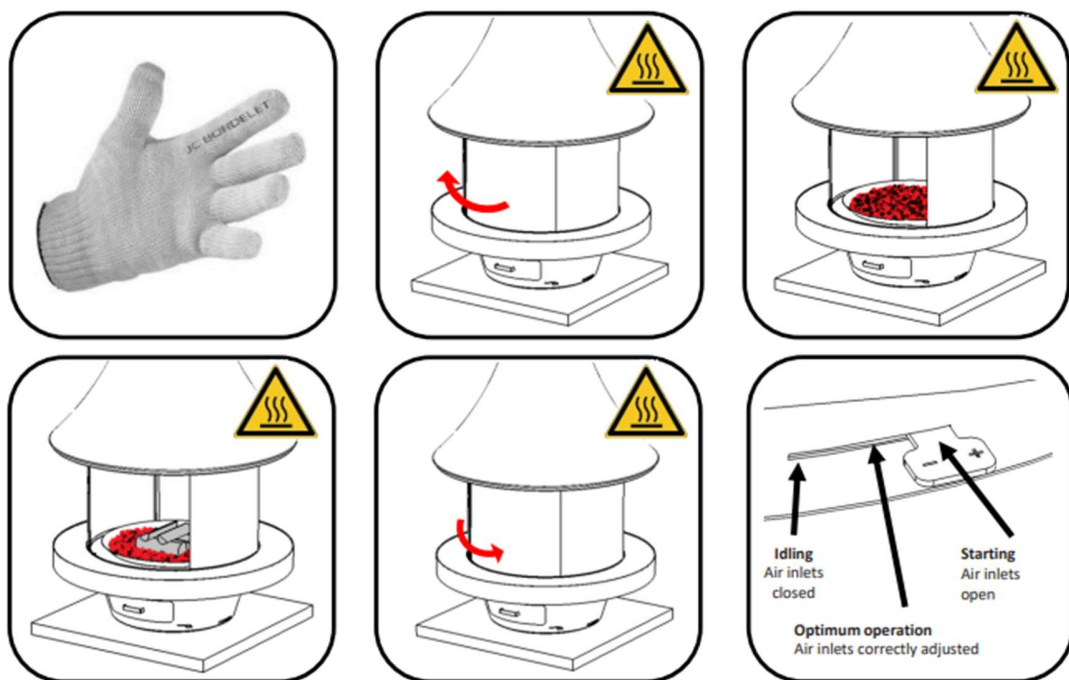

2.3.6 Combustion Air

As is common with closed fireplaces, the combustion air control, located on the base below the fireplace shelf, sets the flow of air entering the firebox which allows for a more precise control of the fire. The quantity of combustion air entering the firebox can be increased by moving the combustion air control from the left (min.) fully to the right (max.). The combustion air control and smoke pipe damper should be in the closed position when the fireplace is not in use to minimize air leakage up the chimney. In preparation for using or cleaning out the fireplace and before opening the sliding glass panels with the cool hand tool, open the combustion air control fully to minimize the possibility of a back draft coming from the fireplace into the room and blowing ashes all over the floor.



2.3.7 Combustion Settings

Accelerated Combustion:

The maximum heat output for the EVA 992 fireplace is achieved with the combustion air control fully opened. By this method, the fireplace can produce a maximum heat output of 55,000 BTU/hr with 2 large or 3 medium size pieces of wood (Max 11kg/24 lbs). However, it will be necessary to reload with wood every 2-3 hours. Use caution when firing with the combustion air control fully open. Only burn cordwood in this manner. Small dry pieces of softwood will burn very intensely using this method and may damage the fireplace or Vitroceram sliding and fixed glass panels.

Medium Combustion:

This is the recommended mode for operating the EVA 992 fireplace and should be the one normally used since it will deposit the least amount of creosote on the sliding and fixed glass panels and in the chimney. The combustion air control should be set to half-open as a starting point. The most efficient setting will vary depending on many factors including chimney length and the moisture content of the wood. For instance, a longer chimney will necessitate adjusting the combustion air control between quarter open to half-open to obtain proper combustion. Two large or three medium size pieces of firewood (Max. 11kg/24 lbs) should be burning over a bed of hot coals. The heat output will be approximately 30,000 BTU/hr and the reloading time will be about every 3-4 hours. Softwoods may be burned using this method but the reloading intervals will be shorter.

Slow Combustion: (Not Recommended)

When the air combustion control is nearly closed, the fireplace is in a slow combustion phase. If the hearth is hot enough, slow combustion will not stop the fire, but there will be a noticeable change in the flame pattern. The flames will be slow and may appear dirty if the wood is too wet (moisture content of 20% and more). This method of operation is not recommended and will produce excessive creosote in the fireplace, smoke pipe and chimney. Creosote may also accumulate on the sliding and fixed glass panels.

2.3.8 The Use of Composite Ecological Logs

Ecological logs made of 100% wood residues do not pose a threat to your fireplace. However, they must be used carefully. Ecological logs typically release a much larger heat output over a short period of time. Therefore, it is not possible to place a large quantity of such logs into the fireplace. One 1.37Kg (3 lbs) ecological fire log gives off 7,700 btu/hr over a 3 hour burn period, therefore the EVA 992 CFF can only burn a maximum of seven(7) fire logs (Max. 9.6 kg/21 lbs) simultaneously.

WARNING: Use only ecological logs meeting the requirements of ULC/ORD-C127-M1990, Composite Fire logs. Prior to use, refer to the fire log warning and cautions as indicated on the packaging. Do not poke or stir ecological fire logs while they are burning. Burning more than of seven fire logs (Max. 9.6 kg/21 lbs) of fire logs at one time can overheat and damage the EVA fireplace and chimney.

2.3.9 Smoking - Causes and Troubleshooting

Your fireplace has been designed and tested to provide smoke free operation. To reduce the likelihood of smoking when opening the sliding glass panels, set the combustion air controls to full open before opening the sliding glass panels. Occasionally, there may be a small amount of smoking upon lighting the fire, until the chimney heats up but this should not continue. If the fireplace continues to smoke it is probably for one of the following reasons:

A. Negative pressure in the house: As the fire burns, air is needed to support combustion and the products of combustion go up the chimney. If there is an insufficient replenishment of combustion air through leakage into the house, the fireplace will start to smoke. To temporarily create a combustion air supply, open a window nearby, if this eliminates the smoke, the house is under negative pressure. This can be corrected by installing an Outside Combustion Air intake. Call a contractor to install an Outside Combustion Air intake of 100 mm (4") in diam. with a maximum length of 4 m (13'-1/8"). If a longer length is needed, go to a 155mm (6") pipe up to max. length of 6 m (20') .

In snowy climates, the air intake hood should be located 30cm (12") above the maximum snow level for that climate or a minimum 1.2m (48") above ground level and be sheltered from high winds. Place the exit of the combustion air intake in the room where the fireplace is installed or in an adjacent connecting room as per ANSI Z 223.1/NFPA 54.

Caution: the Outside Combustion Air intake must not come from an attic, garage, carport, basement, the chimney's enclosure or be less than 3m (10') from a gas meter, a fuel/propane tank or any other device that may emit fumes or gases, such as the exhaust of a motor vehicle.

B. Fans operating: (e.g.: range hood, bathroom exhaust fan, clothes dryer)

These fans draw air out of the house and may actually cause a negative pressure in the house. Turn off all fans and clothes dryer(s) when the fireplace is in operation.

C. Wet wood: Wet or tarred wood will smoulder and smoke instead of burning properly.

D. Dirty or blocked chimney: Check to make sure the chimney is clear and clean.

E. Chimney not long enough: The chimney must extend at least 915 mm (3') above its point of contact with the roof and at least 0.6 m (2') higher than any roof or wall within 3 m (10') of it. When

installed with offsets, only two 45° elbows permitted, the minimum system height is 4.6m (15') to 5.2 m (17'). Additional height will increase draft and will decrease the tendency to smoke. If only the minimum chimney height is installed, operating conditions must be optimal; interior chimney, minimum height of 45cm (18") of smoke pipe before any offset, and total respect of the chimney manufacturer installation instructions.

F. Poor chimney draft: With proper chimney draft and no fire, there should be sufficient draft to exhaust cigarette smoke introduced into the fireplace. In areas where the outdoor temperature may fall to -18°C(0° F) or below, the use of an exterior chimney without an insulated enclosure will result in operating problems such as difficult fire ignition, down-drafting and flow reversal, backdraft of smoke, poor draft, excessive condensation of combustion products and rapid accumulation of creosote when connected to a wood burning fireplace. As a precaution, always provide a properly insulated enclosure around the chimney if it is outdoors. Even with a properly insulated enclosure around the chimney, there might still be draft problems caused by extremely cold weather. To correct this, it is recommended to preheat the chimney by holding a lit rolled up newspaper inside the fireplace towards the smoke pipe until the draft is sufficient and then start the fire.

2.4 MAINTAINING THE EVA FIREPLACE AND CHIMNEY

2.4.1 Fireplace and Chimney Maintenance

Regular chimney inspection and maintenance before and during the heating season combined with proper operation will prevent chimney fires.

2.4.2 Annual and Seasonal Inspections

1. Before the heating season, have a chimney sweep or authorized service person inspect the interior and exterior of the fireplace, smoke pipe and chimney to make sure that all of the components are solidly secured and leakproof, that there is no deterioration or obstructions such as bird nests, etc. If there is a build-up of creosote above 3mm (1/8"), have the smoke pipe, smoke pipe damper and chimney swept using a stiff plastic or non-metallic brush to prevent damaging or scratching the stainless steel interior of the chimney. Also have him clean out any accumulation of ash in the ash pan below the two-piece grate.

Note: The rain cap must be removed for inspection and/or cleaning of the chimney.

2. During the heating season have the smoke pipe/chimney system inspected twice. Do not allow more than 3 mm (1/8") creosote build-up in the smoke pipe and chimney. The amount of creosote accumulation will depend on variables such as frequency of use and type of fire. In the presence of a build-up of more than 3 mm (1/8") of creosote, have the smoke-pipe damper, smoke pipe and chimney swept by a qualified chimney sweep only using a stiff plastic or non-metallic brush. After he has finished sweeping the smoke pipe/chimney system, he must also verify that all of its components are solidly secured and leakproof.

3. Do not expect chemical cleaners to keep your chimney clean.

2.4.3 Care and Cleaning of the exterior of the Fireplace

1. Do not attempt to clean the painted surfaces of the fireplace, smoke pipe or Load Bearing Support until the paint is well cured after several fires as this may damage the factory applied finish which is not covered under warranty. Before cleaning, wait until all the components are cool to the touch and then clean with a soft humid sponge. Do not use any metal polish or abrasives. Do not touch, rub or try to clean the fireplace and smoke pipe when hot. For deep scratches, touch them up with heat resistant paint as supplied by JC Bordelet S.A.S.

2.4.4 Ash Disposal

As a precaution, do not attempt to clean out the fireplace when the unit is hot. Wait until the ashes and the internal components have thoroughly cooled (min. 24 hours) before removing the ashes from the fireplace.

1. Fully open the sliding glass panels with the cool hand tool and make sure that the two-piece grate and all cinders have thoroughly cooled .
2. Using an all-metal industrial type vacuum cleaner such as a Charlescraft Bad Ash 2, clean out the ashes on top of the grate. Then immediately empty the vacuum cleaner into a metal ash container with a tight fitting lid. The closed ash container should then be placed on a non-combustible floor or on the ground outside, well away from combustible materials pending final disposal. If the ashes are to be disposed of by burial in soil or otherwise locally dispersed they should be retained in the closed container until all cinders have thoroughly cooled.
3. Close sliding glass panels with the cool hand tool.

Note: At least twice a year, have a chimney sweep or authorized service person clean out any accumulation of ash in the ash pan below the two-piece grate.

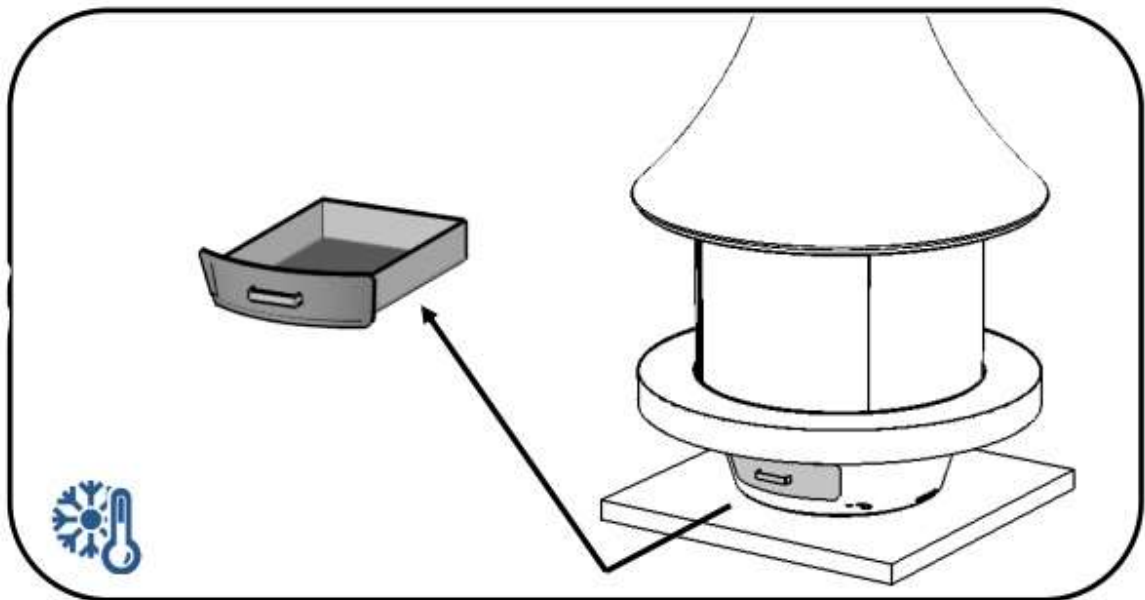

WARNING: DO NOT ABUSE THE SLIDING GLASS PANELS BY SLAMMING THEM AGAINST

2.4.5 Glass Care-Cleaning

Keep the glass panels relatively clean. Dirty Vitroceram sliding and fixed glass panels will make the fireplace overheat. Wait until the glass panels are cool before attempting to clean them. Wash the glass panels with window or oven cleaner, dishwashing liquid or just soap and water. Spray the cleaner on a soft cloth and not on the glass panels, since overspray may discolor the painted finish (not covered by the warranty). DO NOT use steel wool, soap pads (S.O.S.) or any other abrasive product since these may scratch the glass panels.

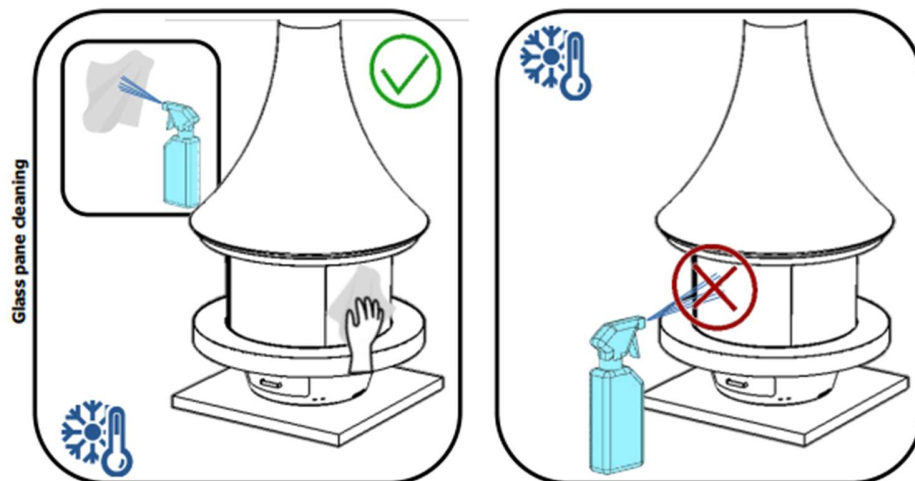

2.4.6 Dealing with a Chimney Fire

Regular chimney maintenance and inspection can prevent chimney fires. If a chimney fire occurs, follow these steps:

1. Keep the fireplace sliding glass panels closed and close the combustion air control;
2. Alert your family to the possible danger and move them to safety;
3. Call the local fire department immediately;
4. If possible, use a dry chemical fire extinguisher, baking soda or sand to control the fire.
Do not use water as it may cause a dangerous steam explosion;
5. Watch for smouldering or fire next to the fireplace, smoke pipe and chimney;
6. Step outside to make sure that sparks and hot embers coming out of the chimney are not setting fire to the roof;
6. Do not use the fireplace again until the chimney and fireplace have been inspected by a Fire Department Inspector.

Caution: Always keep furniture, draperies, and extra logs or combustibles a minimum 1.2 m (48") away from the fireplace.

2.4.7 Installing or replacing the sliding and fixed vitroceraam glass panels

Do not use the fireplace with a cracked or broken Vitroceraam glass sliding or fixed panel. Contact an authorized JC Bordelet S.A.S. installer who will order the replacement parts and install them.

Caution: For replacing broken sliding or fixed panels, use only 4 mm (5/32") Vitroceraam glass made by JC Bordelet S.A.S. and able to resist temperatures that can reach 750°C (1382°F). To installer, always use protective gloves to handle glass.

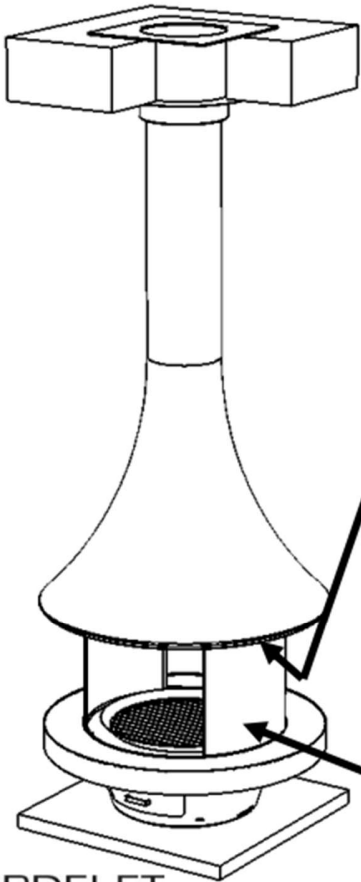

1/ Fixed glass panels installation / replacement

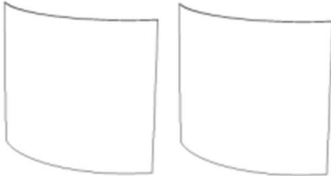

1-Insert the fixed glass panels and place them at their final locations

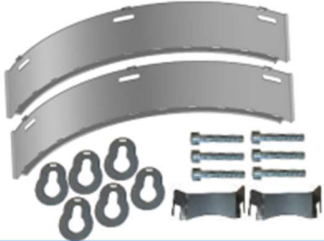

2-Put in place the airwash system. Refer to the assembly details at the end of this manual.



3-Loosen the brackets, put in place the gaskets on the glass panels at the brackets level, screw again the brackets

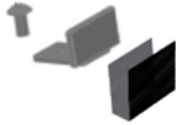
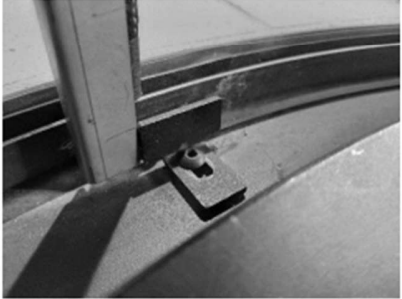

ORDELET
ir d'harmonie

2/ Sliding glass panels installation / replacement

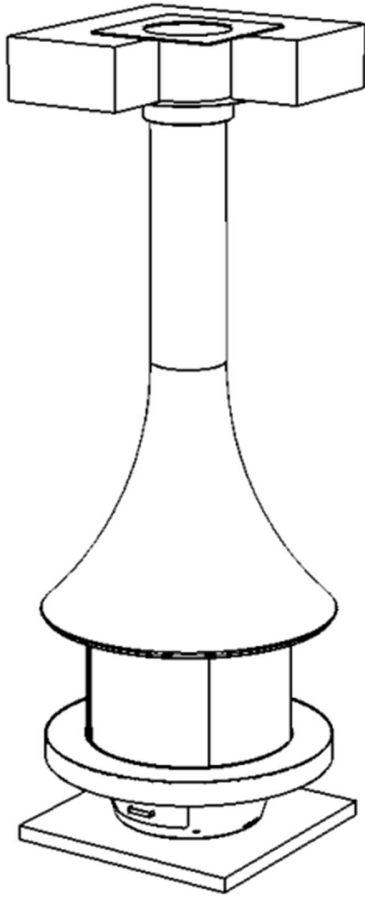

1-Remove the removable plate



2-Insert the sliding glass panels, one after another, inside the rails

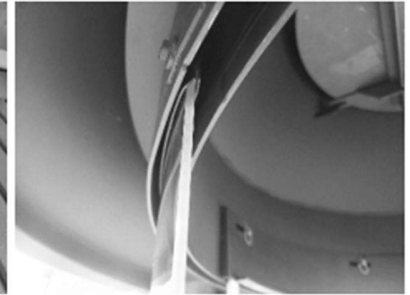

3-Put in place again the removable plate



3/ Air wash system installation

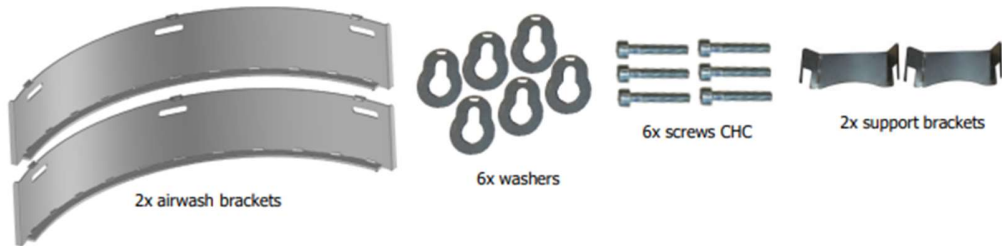

STEPS OF ASSEMBLY

1-Unscrew the fixing screws

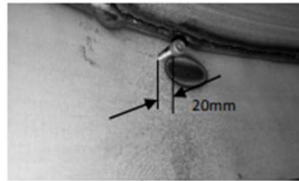
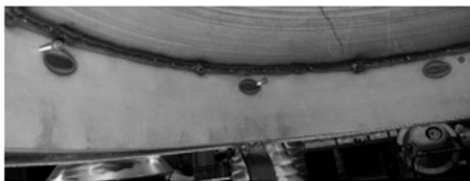

Unscrew the 20mm screws



2-Put in place the fixed glass panel with the support bracket centered on the top part

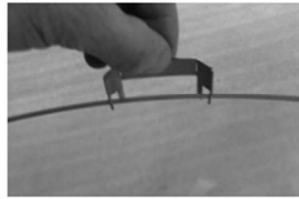
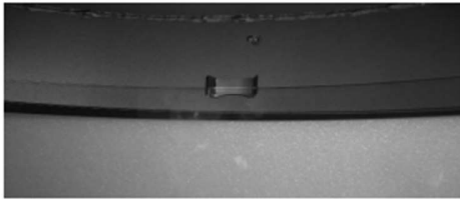

Position the glass inside the firebox after you have added the support bracket



3-Put in place the airwash bracket

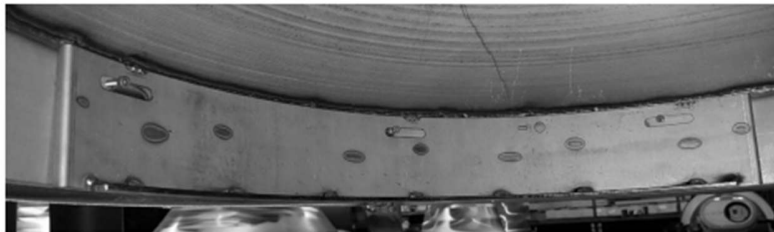

Put in place the airwash bracket, supported on the screws



4-Put in place the washers

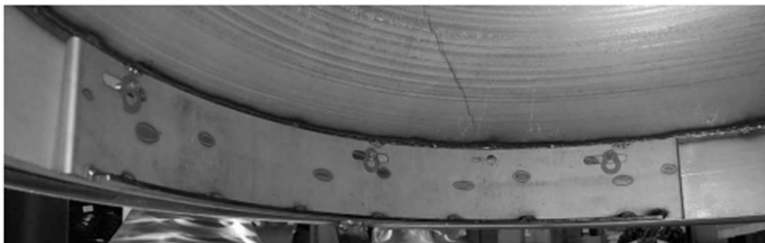

Put in place the washers and screw



2.4.8 Installing or replacing the baffle plate, the ash box and the grate

1. Baffle plate for EVA 992CFF (painted)

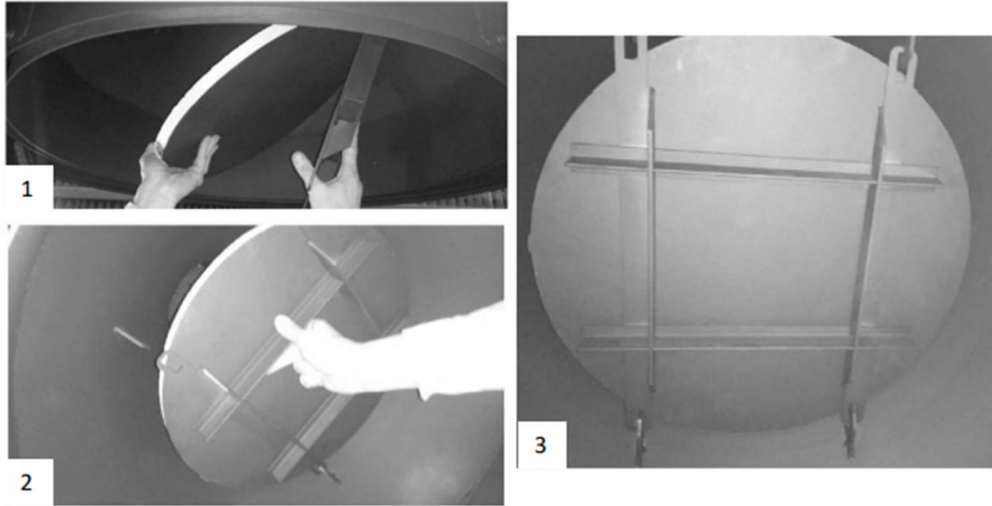

2. Baffle plate for EVA 992CCOLFF (lacquered)

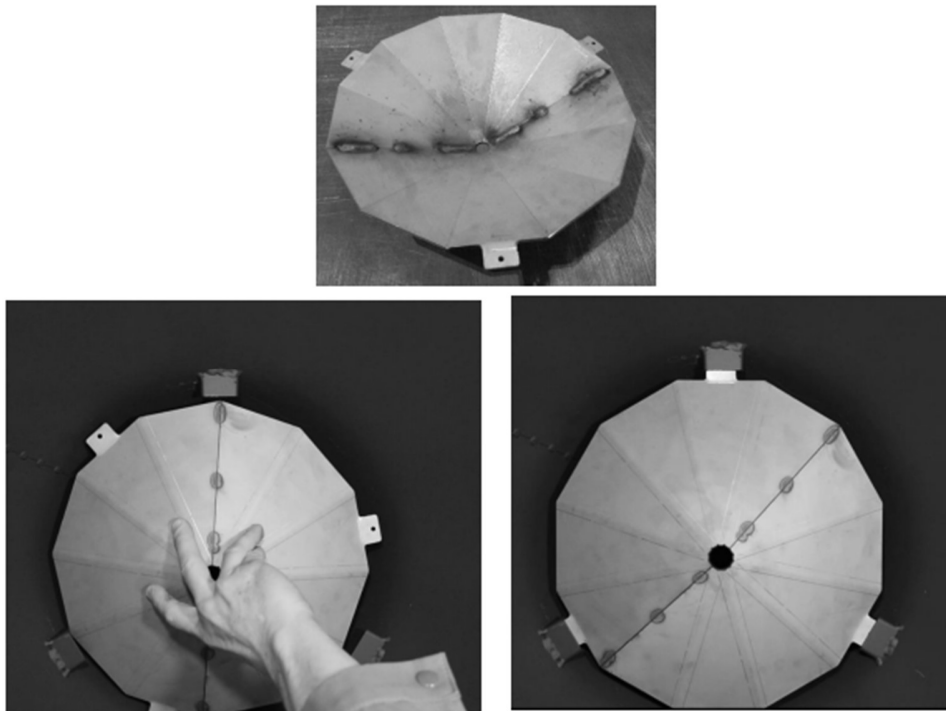

3.Installing Ash box and ash grate

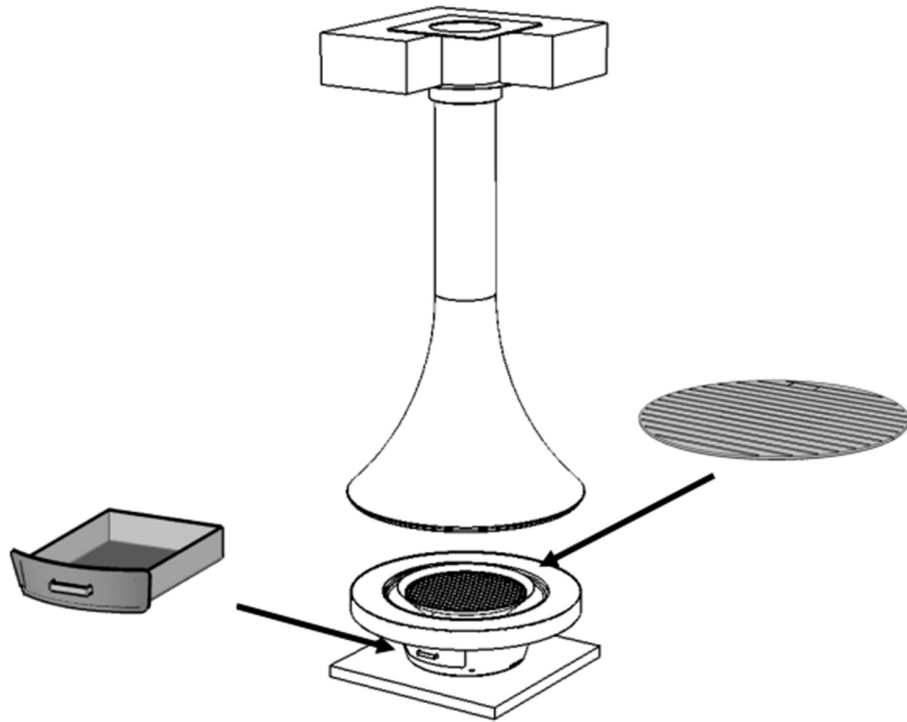

2.4.9 Replacement parts list for EVA 992 Centrally-Located Fireplace

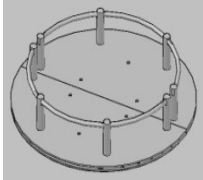
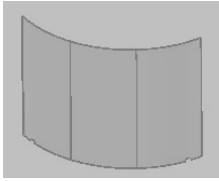
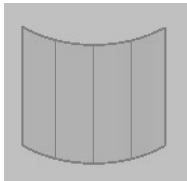
Drawing	Part Name	Part Number
	Grate for EVA 992 Central Model	AGF
	EVA 992 Central Sliding Glass Panels (x2)	VM
	Fixed Glass Panel for EVA 992 Central (x2)	VF

2.4.9 Outdoor Combustion Air Kit

In snowy climates, the air intake hood should be located 30cm (12") above the maximum snow level for that climate or a minimum 1.2m (48") above ground level and be sheltered from high winds. Place the exit of the combustion air intake in the room where the fireplace is installed or in an adjacent connecting room as per ANSI Z 223.1/NFPA 54.

Outdoor Combustion Air Intake (Recommended Option)

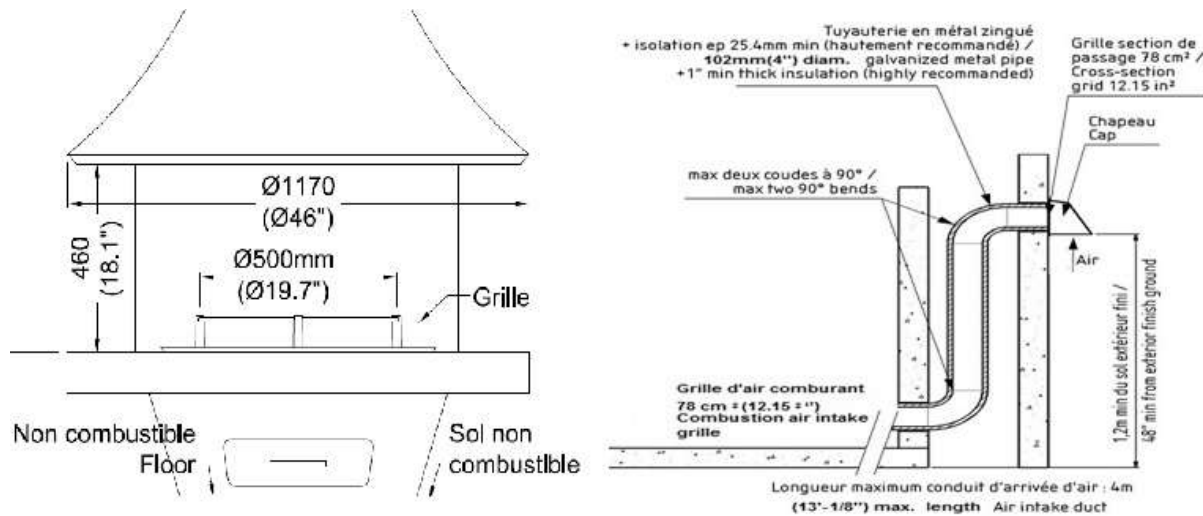

Caution: the Outdoor Combustion Air intake must not come from an attic, garage, carport, basement, the chimney's enclosure or be less than 3m (10') from a gas meter, a fuel/propane tank or any other device that may emit fumes or gases, such as the exhaust of a motor vehicle.

BORDELET INDUSTRIE S.A.S. NORTH-AMERICAN WARRANTY LIMITED WARRANTY

The warranty of the manufacturer extends only to the original purchaser and is not transferable. It takes effect upon completion of the installation of the fireplace by an authorized qualified installer and a copy of the Installation, Operation and Maintenance Manual must be left with the original purchaser at the same time. This warranty covers only new products, which have not been altered, modified or repaired since leaving the factory. Proof of purchase (original dated invoice), model name and serial number must be supplied when making any warranty claim to the local Bordelet Industrie S.A.S. distributor.

This warranty applies to normal residential use only. Damages caused by misuse, abuse, improper installation, lack of maintenance, over firing, negligence or accident during transportation, down-drafts, or venting problems are not covered by this warranty.

An authorized qualified installer must perform the installation in accordance with the instructions supplied with this product and all Local and National building codes. The installer must also verify that the chimney used to vent the products of combustion and all its supports and firebreaks meet all codes and standards and that the chimney's base will be mounted on a JC Bordelet Load bearing Support which will also provide adequate mounting and support for the fireplace suspended from it. The authorized qualified installer will be held solely responsible for any improper installations not in conformance with the ULC-S610 and UL127 standards and Local and National building codes, the supplied installation, operation and maintenance manual and shoddy or negligent workmanship.

The manufacturer may require that defective products be returned to the local Bordelet Industrie S.A.S. distributor to support the claim. Returned products are to be shipped prepaid to the distributor for investigation. If the product(s) is/are found to be defective, Bordelet Industrie S.A.S. will, at their option, repair or replace such defective product(s). The product(s) will be shipped back to the original purchaser freight collect. Repair work done under warranty, executed at the original purchaser's home by an authorized qualified installer requires the prior approval of the local Bordelet Industrie S.A.S. distributor. Bordelet Industrie S.A.S. and its distributor will not be liable for any and all labour and traveling or shipping costs associated with the repair, removal, reinstallation of any one of its fireplaces or individual component nor administration fees incurred by the original purchaser.

The manufacturer, Bordelet Industrie S.A.S., at its discretion, may decide to repair or replace any part or unit after inspection and investigation of the defect. Additionally, Bordelet Industrie S.A.S. may, at its discretion, fully discharge all obligations with respect to this warranty by refunding the wholesale price of any warranted but defective parts. Bordelet Industrie S.A.S. shall in no event be responsible for any special, indirect, consequential damages of any nature, which are in excess of the original purchase price of the product.

WARRANTY COVERAGE

Five Years from date of installation: All components incorporated in the fireplace at the factory.

One Year from date of installation: Baffle plates, ash grille, the expanded metal mesh firescreen.

EXCLUSIONS:

This warranty does not cover any corrosion due to a saline or corrosive environment, distortion, scratches or discoloration due to over firing, damages incurred during shipping, nor any damages caused by improper assembly or mounting or improper use of the fireplace. Any defect or damage caused by the use of unauthorized parts or other than original parts void this warranty. Any service call related to an improper installation or use is not covered by this warranty.

Within ten days from date of installation, the original purchaser must register his warranty by sending the attached warranty card to the local Bordelet Industrie S.A.S. distributor whose name and address will be furnished by the authorized installer.

If during the warranty period the fireplace or a component ever becomes defective, the original purchaser must provide the following information when contacting his Bordelet Industrie S.A.S. installer:

His name, address and telephone number; a copy of the installer's invoice showing the date of installation and the model name and serial number of the fireplace, also he must verify that the same information appears on the nameplate affixed to the fireplace and any other information that might help in identifying the nature of the problem.

All implied warranties of merchantability and fitness for a particular use or purpose are hereby disclaimed with respect to all buyers/users. Some provinces and states do not allow the exclusion or limitation of incidental or consequential damages so the above limitations might not apply.

This warranty replaces any other expressed or implicit warranty and constitutes the sole obligation of Bordelet Industrie S.A.S.. towards the original purchaser. This warranty does not cover cost of removal, reinstallation or shipping to repair or replace the defective part(s) nor administration fees incurred by the original purchaser.

Bordelet Industrie S.A.S.. reserves the right to make modifications in the design, construction, or material which in it's judgment constitutes an improvement over previous design or manufacturing practices.

This warranty is only valid for installations made within the territorial limits of Canada or the Continental United States. In order to benefit from this warranty, the original purchaser must first receive a written return authorization from the local Bordelet Industrie S.A.S. distributor and work with the original installer to ship, any and all defective parts, freight prepaid back to the distributor.

Warranty Card
Date of manufacture: yr _____ /mm _____ /dd _____
Date of installation: yr _____ /mm _____ /dd _____
Model number: _____
Name and address of original purchaser: _____ _____
Signature: _____
Always include a copy of the bill of sales showing the date of installation